

SURROUND by Laminex®



Fabrication & Installation Manual

Surround by Laminex® is designed for interior area applications and is manufactured from moisture resistant Medium Density Fibreboard (MDF). Each panel has one face routed with a regular decorative pattern which is primed with water-based paint.

Applications

Wall and ceiling panelling.

Functional Benefits



Vertical Application



Horizontal Orientation on Walls



On Ceilings



Curving¹



Internal Moisture Areas¹



Impact Resistant



Dimensional Stability



Low Sanding



Paintable

PEFC & Global GreenTag^{Cert}™ Certified



Make sure your information is up to date

When specifying or installing Surround by Laminex, ensure you have the current technical documents. If you are not sure you do, or you need more information, visit laminex.co.nz or call Laminex New Zealand® on 0800 303 606.

¹MR E0 MDF product only. Additional considerations and steps required. Surround by Laminex is prohibited for use in splash zones. Fire Resistant product (E1 MDF FR) is prohibited for use in Internal Moisture Areas and for Curving. Curving should only be undertaken by a person experienced in kerfing and mould making. Follow all instructions outlined in the latest Fabrication and Installation Manual.

²PEFC and Global GreenTag certification only applies to MR E0 MDF product.

Cover

Scallop 135 is applied to a café wall, finished with Scallop 45.

1.0 Introduction	Page
1.1 Purpose of this manual	5
2.0 General Information	
2.1 Safety	6
2.1.1 Safety data sheet	
2.1.2 Personal protective equipment	
2.1.3 Tools and equipment	
2.1.4 Adhesives	
2.2 Handling	7
2.3 Storage	8
2.4 Packaging	9
2.5 Transporting	9
2.6 Conditioning	9
2.7 Quality control	10
2.7.1 Inspection	
2.7.2 Technical data	
2.8 Care and maintenance	10
2.9 Warranty	10
3.0 Applications	
3.1 Interior	11
3.2 Exterior	11
4.0 Design Guidelines	12 – 13
5.0 Fabrication	
5.1 Tools and equipment	14
5.2 Cutting	14 – 15
5.3 Openings and cut-outs	15
6.0 Installation	
6.1 Planning	16
6.2 Fixing	17
6.2.1 Nails	
6.2.2 Screws	
6.3 Expansion gaps and dimensional tolerance	18
6.4 Fixing to timber stud walls and/or steel framed walls	19 – 20
6.4.1 Preparing the wall	
6.4.2 Installing the sheets	

6.0 Installation (continued)	Page
6.5 Fixing to plasterboard	21 – 22
6.5.1 Checking and preparing the wall frame behind the plasterboard	
6.5.2 Installing the sheets	
6.6 Fixing to brick and block walls or masonry	23 – 25
6.6.1 Preparing the wall	
6.6.2 Installing the sheets	
6.7 Installation in a horizontal orientation on walls	26 – 27
6.7.1 Planning join locations	
6.7.2 Installation	
6.8 Installation in Internal Moisture Areas	28 – 35
6.8.1 Fixing to plasterboard walls	
6.8.2 Fixing to timber stud walls and/or steel framed walls	
6.8.3 Fixing to brick and block walls or masonry	
6.8.4 Painting panels in Internal Moisture Areas	
6.9 Installation on ceilings	36 – 41
6.9.1 Planning and installation	
6.9.2 Installing the panels	
6.9.3 Ceiling finishing	
6.10 Use and fixing of dado rails and mouldings	41
6.11 Installation adjacent to fireplaces	42 – 44
6.12 General power outlets (GPO)	45
6.12.1 General power outlets (GPO) – for curved profiles	
6.12.2 General power outlets (GPO) – for flat profiles	
6.13 Skirting boards	46
6.14 Curving panels guide	47 – 52
6.14.1 Guidance for kerfing	
6.14.2 Installation and finishing process – structure	
6.14.3 Installation and finishing process – walls	
7.0 Finishing	
7.1 Painting	53
Important Information	54

1.1 Purpose of this manual

This manual has been created to provide clear instructions required to successfully design, fabricate and install Surround by Laminex®. Adherence to the techniques and guidelines presented in this manual will ensure the finished article is compliant with the conditions in the product warranty.

Throughout this manual the symbol  will appear against any specific instructions that are linked to compliance with the Surround by Laminex, warranty.

This manual has been developed to allow designers, fabricators and installers who work with Surround by Laminex to achieve performance standards for both domestic and commercial applications.

It is important to note that the techniques and guidelines presented in this manual are those recommended for use with Surround by Laminex. Any variation from these guidelines may create unexpected performance problems and may void the limited warranty.

It is impossible to cover all the existing fabrication techniques in this manual. This manual provides instructions to comply with the product warranty and is not intended to replace any testing you may need to conduct to determine the suitability of this product for your particular purpose and needs.

While every precaution has been taken in the preparation of this document, Laminex New Zealand® assumes no responsibility for errors or omissions, or for damages resulting from the use of information contained in this document. In no event shall Laminex New Zealand® be liable for any loss of profit or any other loss or damage caused or alleged to have been caused directly or indirectly as a result of any person relying upon any information contained in this document.

Content in this manual is subject to change at any time without notice. Refer to laminex.co.nz for the latest revision of this document.

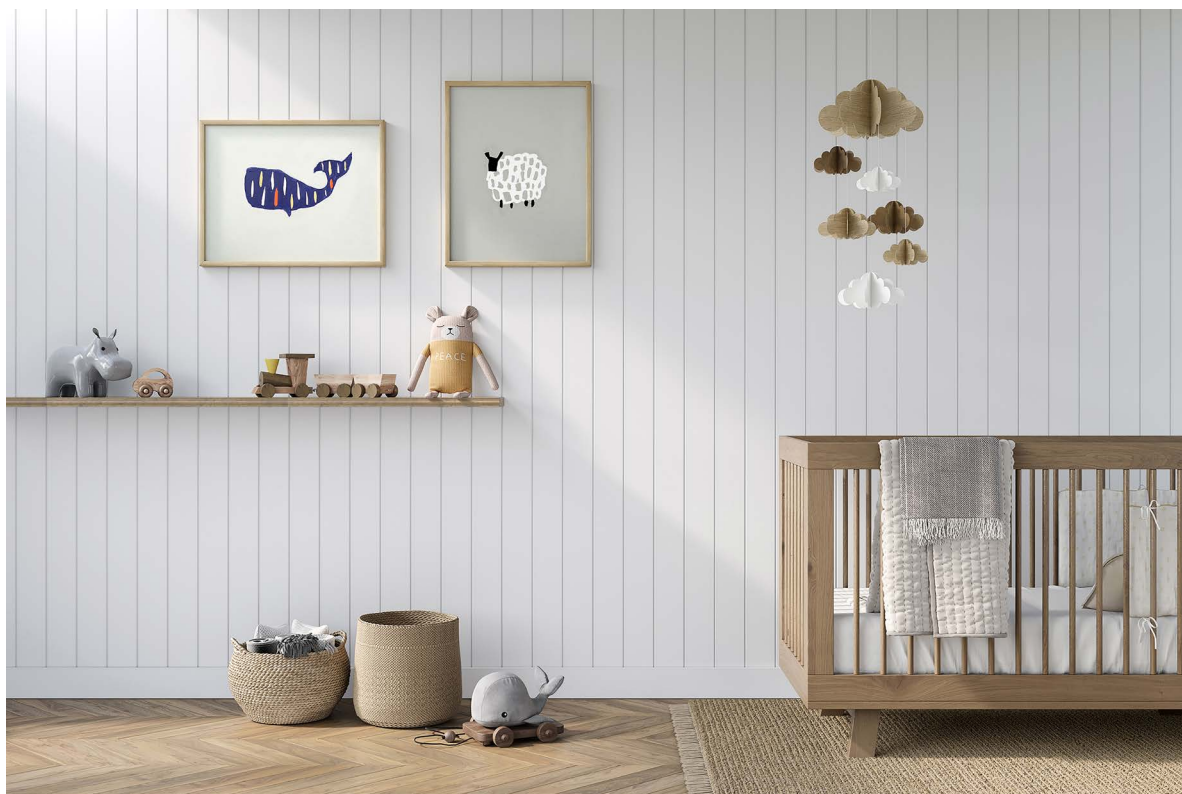

Classic VJ 100 creates a delightful hard-wearing wall in this neutral nursery.

2.1 Safety

Safety training, product knowledge and product use are the responsibility of the fabrication facility and its employees.

Equipment selection, use and maintenance are the responsibility of the fabrication facility and its employees.

Maintaining a clean and adequately ventilated workplace is the responsibility of the fabrication facility and its employees.

2.1.1 Safety data sheet

Refer to laminex.co.nz for the latest version of the Safety Data Sheet (SDS) for this product.

2.1.2 Personal protective equipment

Always wear appropriate PPE when handling, cutting or fabricating this product. Wear gloves, safety footwear and suitable workwear apparel (no loose clothing or jewellery).



Occupational exposure to any type of dust is known to be hazardous to human health. Care must be taken to avoid the inhalation of dust. Follow good hygiene and workplace practices. Dust can be vacuumed or swept to avoid accumulation. If dust levels exceed WorkSafe New Zealand standards, a dust mask must be worn in accordance with AS/NZS 1715 and AS/NZS 1716.



Always use safety glasses or approved eye protection and/or face shield when cutting, routing and sanding. In line with WorkSafe New Zealand standards, goggles or safety glasses should be selected, used and maintained in accordance with AS/NZS 1336 & AS/NZS 1337.



2.1.3 Tools and equipment

Use and maintain all tools and equipment in accordance with manufacturer's instructions.

Keep all equipment safety guards and dust collection devices in place.

2.1.4 Adhesives

Always refer to the manufacturer's Technical Data Sheet (TDS) and Safety Data Sheet (SDS) for instructions on how to store and use solvents, adhesives and other materials in a safe manner. Refer to recommended adhesives found on page 14.

2.2 Handling

This product weighs approximately 9.5 Kgs/ m² and should not be manually lifted by less than two people. Carry full sheets vertically, where practicable to avoid flex or possible breakage.



The use of mechanical aids, such as vacuum lifting devices, are recommended for handling large panels. Care should be taken to lift panels from the non-routed face.

- Ⓜ If moving or transporting panels via forklift or suction lift, move sheets carefully to avoid damage and ensure the right forklift tyre length is used for the sheet size. Do not overload the forklift.

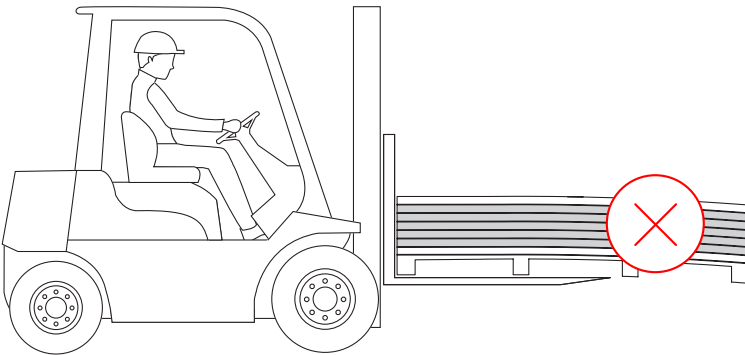

- Ⓜ DO NOT slide panels over one another to move them.

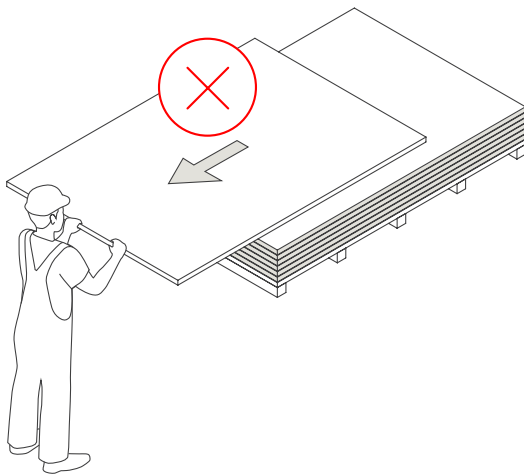

- Ⓜ Always gently lift and place the panels to avoid damage to the decorative surface.

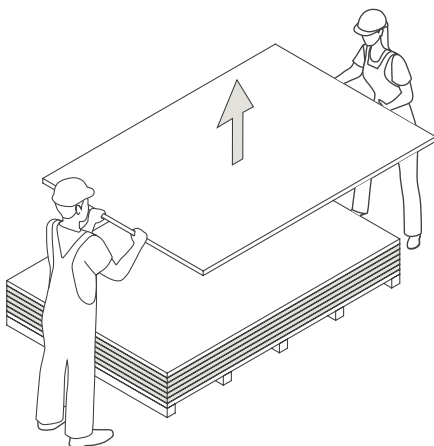

2.3 Storage

- Ⓜ When working with loose sheets of Surround by Laminex®, where the original packaging is removed, the sheets must be stored horizontally in a flat level fully supported manner. Place a protective cover over the unused sheets.
- Ⓜ Packs must be stored on a level horizontal surface and aligned with each other.
- Ⓜ Material must be stored in a dry, fully enclosed area away from exterior doors. Do not leave Surround by Laminex in the rain, wind and protect from UV light.
- Ⓜ DO NOT store Surround by Laminex within areas where newly poured concrete or wet plastering is present.
- Ⓜ When working from a pack of Surround by Laminex, use sheets as required and place a protective cover over the unused sheets.
- Ⓜ Do not store product on pallets with bearer spacings more than 600mm apart.

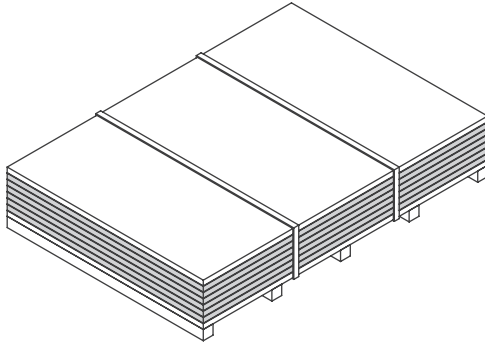

- Ⓜ Do not stack different sized packs on top of each other.

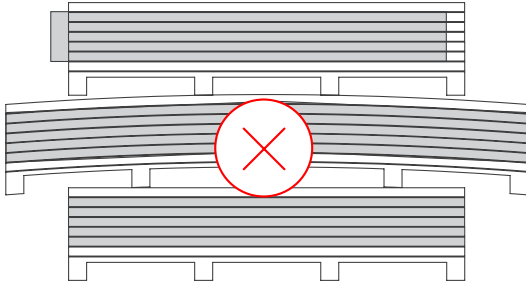

- Ⓜ Do not stack more than three packs high.

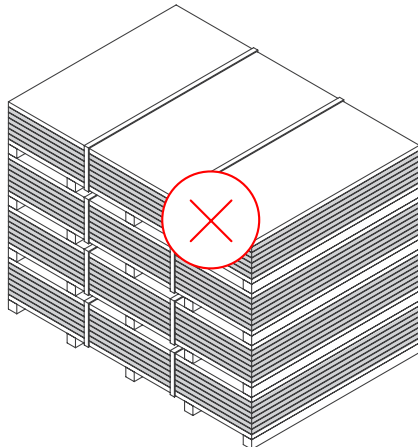

2.4 Packaging

The use of suitable packaging is essential to controlling and maintaining moisture content equilibrium (MCE). An imbalance of moisture will result in bowing or warping of the material.

- Ⓢ Coversheets of the same material (top and bottom) must be used to minimise the risk of bowing.

2.5 Transporting

It is important to take precautions when transporting Surround by Laminex®. Ensure product surfaces and edges are well protected when transporting, storing, fabricating and installing sheets.

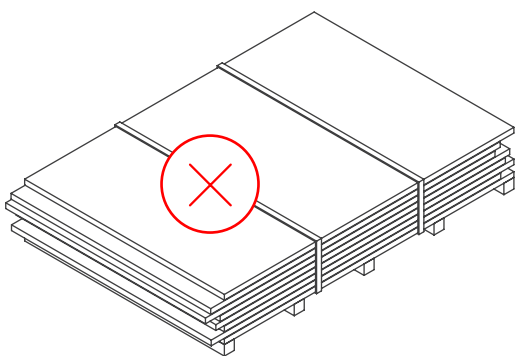

All straps and restraint devices must remain grit and burr free and suitably tensioned to prevent movement of the product when transporting. Covered loads are recommended to prevent damage during transportation.

- Ⓢ Claims for damage or surface abrasion due to unsuitable transportation methods will not be recognised.
- Ⓢ During transportation, use flat, stable supports of at least the same dimensions as the material.

2.6 Conditioning

Pre-conditioning of Surround by Laminex panels is required in order to achieve moisture content equilibrium (MCE) before fixing, to reduce the likelihood of bowing or shrinkage after installation.

Therefore, Surround by Laminex panels must be stored for a minimum period of 48 hours at the same environmental conditions as the subsequent place of use.

Failure to condition material may result in product expansion and contraction in response to environmental conditions, particularly with changes in temperature and humidity. This may result in, but is not limited to, bowing or warping of panels, joint failure or build-up of internal stresses that release in the form of cracks.

Surround by Laminex must be installed in locations where environmental conditions can be controlled and maintained in a manner to avoid large fluctuations in temperature or humidity.

- Ⓢ Failure to adhere to conditioning guidelines will void your warranty.
- Ⓢ Failure to maintain and control temperature and humidity of installation environments will void your warranty.

Timber structures to which Surround by Laminex panels are fixed, will also respond to changes in humidity and temperature of the surrounding environment. Hence, it is important that temperature and humidity are effectively controlled to minimise fluctuations in moisture content. Inadequate control of these parameters may result in expansion or contraction of the framing.

2.7 Quality control

2.7.1 Inspection

- Ⓢ ALL sheets must be visually inspected prior to the commencement of ANY cutting or fabrication.

Before commencing any cutting or fabrication, the following must be checked:

- Correct items (thickness, routed design, etc).
- Consistent routed design (ensure panels for the same installation are inspected for routed design compatibility).
- Inspect for defects, such as: chips, scratches, evidence of transportation damage, general quality of the surface finish and quality of the edge. Some minor scuffing of the surface during transportation is possible, light sanding prior to painting will rectify this.

If products are believed to be defective, record all order details and contact your Laminex representative as soon as possible.

- Ⓢ Once cut or fabricated, no claims will be recognised for any visual defects.

2.7.2 Technical data

Refer to laminex.co.nz for the latest version of the Technical Data Sheet (TDS) for this product.

2.8 Care and maintenance

Refer to your paint supplier for care and maintenance of the final finished painted surface.

2.9 Warranty

Surround by Laminex® is covered by a 7 year limited warranty.

Refer to laminex.co.nz for the latest version of the warranty for this product.

3.1 Interior

- Ⓜ Surround by Laminex® is ONLY suitable for interior wall panel and ceiling applications.
- Ⓜ Surround by Laminex is NOT suitable for any cabinetry or flooring applications.
- Ⓜ Surround by Laminex must NOT be adhered to tiles, cork, natural stone, textiles, wallpaper, timber panelling or hardboard.

3.2 Exterior

- Ⓜ Surround by Laminex is NOT suitable for use in any exterior applications.

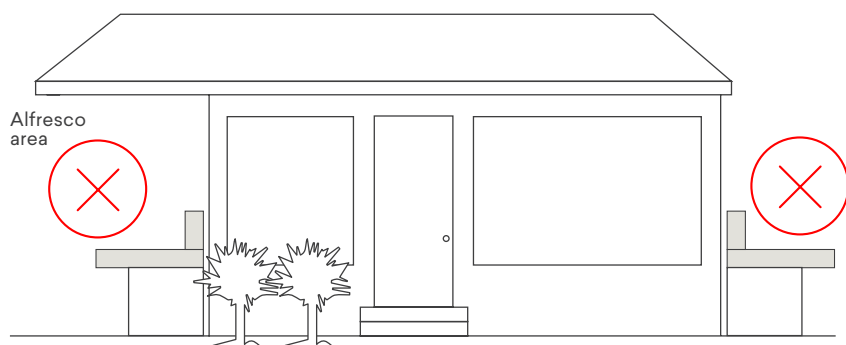

Planning and design

When you are in the planning and design stage of your project, there are some important points to consider, so that your installation meets the compliance requirements for the Surround by Laminex® warranty.

Key considerations for your Surround by Laminex project include both aesthetic detailing and the planning of the location or room in which the panels are to be installed.

Surround by Laminex is **ONLY** suitable for interior wall and ceiling panel applications.

Panels are NOT suitable for the following applications:

- Any external installation.
- Fixed to sliding doors or internal honeycomb construction doors.
- Floors.
- Cabinetry.
- Adhered to tiles, cork, natural stone, textiles, wallpaper, timber panelling or hardboard.

Non-compliant use of panels will not be considered under warranty.

You should ensure that project specification documents include both fabrication and installation documents and should follow all technical requirements of the Surround by Laminex Fabrication and Installation Manual.

Wall suitability is important for the successful installation of Surround by Laminex panels. Minor modifications to studs and wall frames may be required. Please consult with a qualified tradesperson as required for this work.

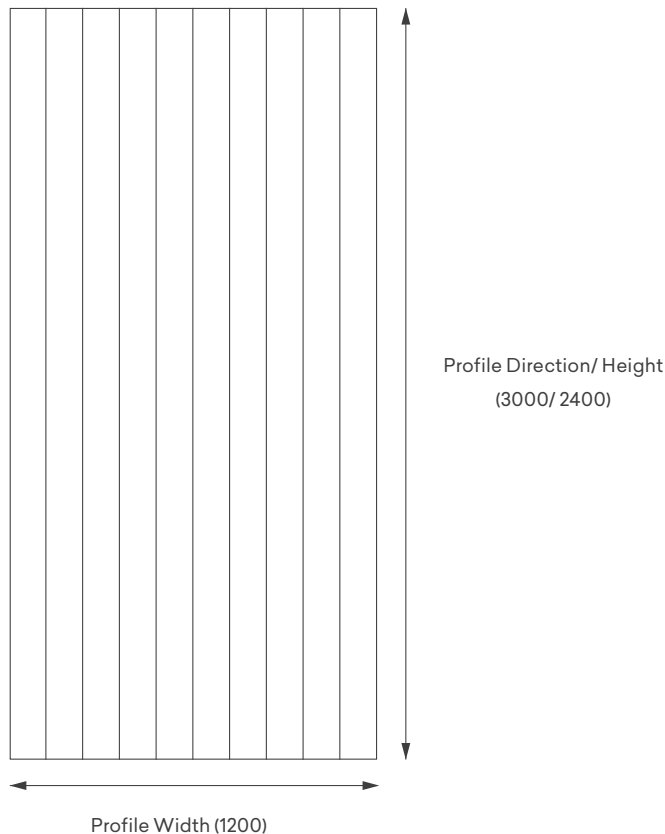

Design checklist

Your project design checklist should include consideration of the following:

- Position of existing or planned windows, doors and openings, GPO's (electrical outlets), light and fan controls, air conditioner vents and other cut-outs through the panel for functional appliances. Always use an electrician when working around electrical outlets.
- Height of panels to be used:
 - Will full height panels or partial height panels be installed?
 - If using partial wall height panels, what paint or other finish will be used for the balance of the wall?
 - Partial wall height panels may also require additional reinforcement and/or wall modifications to support the top of the panel.
- Expansion joints must be maintained throughout between Surround by Laminex® panels and all architectural elements such as floors, ceilings, architraves, skirtings, fixtures and fittings and between panels.
- Consider the direction of the wall panel design selected. Always use the joining tongue and groove system. Butt joining of sheets (where no tongue is used) is not recommended and is not covered by warranty.
- Minimum distances from the edge of Surround by Laminex panels must be maintained for items to be cut in. Any access cut-outs for GPO's (electrical outlets), air conditioning vents, light switches, or similar, must not occur less than 150mm from the edge of the Surround by Laminex panel. Always use an electrician when working around electrical outlets.
- Consider the specific design of the Surround by Laminex panels selected for use and the surface of the intended walls.
 - Is the scale and directionality of the design a good fit?
 - Also consider the uninterrupted areas of the project, areas that might involve multiple cut-outs around fixtures and fittings, as well as change of direction through internal and external corners.
- If more than one design of Surround by Laminex wall panelling is considered for the project, the appearance of the panels in both the height and the width of the wall is important. The use of different designs together is recommended with the addition of a dado rail applied along the interface join between the two profiles.
- When considering using Surround by Laminex on a ceiling, take into account both the wall and ceiling profiles to ensure they complement each other.
- Mouldings and dado rails:
 - If the use of mouldings and dado rails is anticipated, how high up the wall should they appear?
 - Will they be interrupted by architraves on windows or doors?
 - What is the optimum height to achieve an unbroken line where practical?
- Consult with paint or coating manufacturers for suitability of intended finishes to be applied to Surround by Laminex panels. It is recommended to test the intended finish on the pre-primed surface before project commencement.

5.1 Tools and equipment

This is not an exhaustive list, but it is recommended that the following are checked and available:

- Tape measure
- Spirit level/laser Level
- String line or equivalent
- Hand saw or circular saw
- Hammer and/or nail gun or screw gun
- Pencil or chalk for marking out
- Caulking gun
- Sanding sponge

Consumables

- Nails and screws are to be long enough to penetrate studs and noggins by at least 25-30mm beyond the depth of the Surround by Laminex® panel. Check for suitability if using nail guns or screw guns.
- Flexible construction adhesive to be used to glue the panels to the frames or studs and noggins. Ensure that the adhesive permits a 25% movement capability.

Recommended adhesives:

Sikaflex® 123 MS Bond
Sika® Nailbond Premium
Gorilla 240FC
Gorilla MS Sealant.

- PVA adhesive is recommended for gluing corners together and supporting moulding such as dado rails in place before fixing.
- Sealants and/or Gap Fillers to be used when fixing other trims such as timber mouldings skirtings and cornices. A 25% movement capability and paintable finish is required.
- Material off-cuts or other spacers.
- Timber based filler to fill nail/screw holes.

Workplace

Keep work area clean, uncluttered and well lit.

Avoid panel contact with abrasive surfaces, grit or other processing debris. Contamination trapped between sheets will cause surface indentations, marring or scratching.

Avoid contact with solvents, moisture and oil which can contaminate the panels and affect the performance of adhesives and coatings.

When cutting panels ensure that the full panel is well supported before any cutting or processing.

5.2 Cutting

Surround by Laminex panels can be readily cut with a circular saw or hand saw. New or sharpened blades should always be used as blunt or dull blades will decrease the accuracy and finish of cuts.

Surround by Laminex® panels should be cut only on saws that have a scribing blade on the underside.

Continued on next page >

When using a circular saw, cut the panels with the decorative face down and when using a handsaw cut the panels with the decorative face side up. It is recommended that a test piece be cut to verify the correct decorative face position for the specific cutting equipment to be used.

If using a router, do not allow the cutter to take too deep a cut at a time and only trench a maximum of one third of the thickness, per pass.

5.3 Openings and cut-outs

Any internal corner or aperture must be cut with a minimum internal radius of 10mm.

All edges must be smooth and free of damage, cracks, dents or notches.

- Ⓦ Cracks or any other failure attributable to non-compliant openings or cut-outs will not be recognised under warranty.

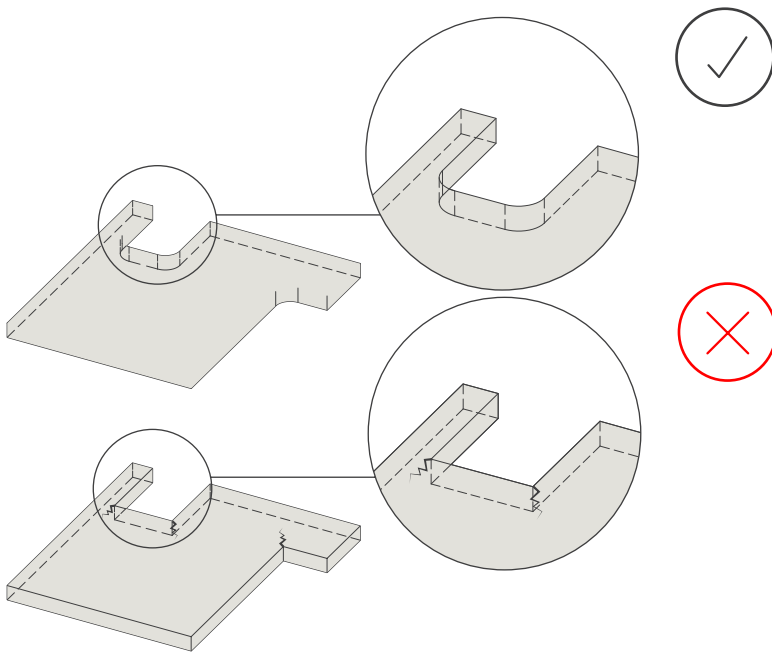

Cut-outs can be made with a router or by pre-drilling a hole with an appropriate diameter drill bit to meet internal radius requirements and then cut between drill holes.

Any access cut-outs for GPO's (electrical outlets), air conditioning vents, light switches, or similar, must not occur less than 150mm from the edge of the Surround by Laminex® panel. Always use an electrician when working around electrical outlets.

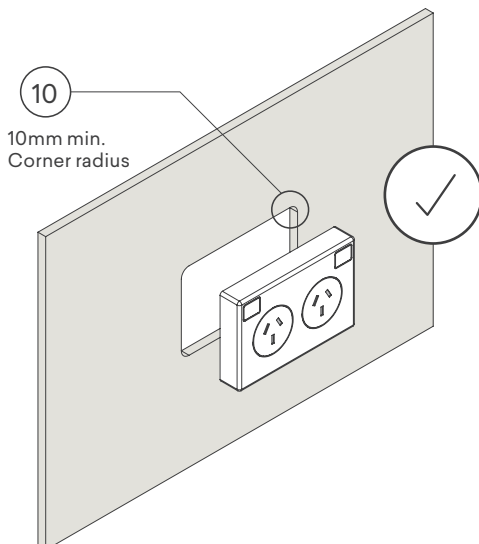

6.1 Planning

Before starting your project using Surround by Laminex® it is important to identify some key attributes of the area in which the material will be placed and to plan the installation of the panels.

Wall type

What kind of wall are the panels to be affixed to? Is it a direct fix to studs, fitted onto masonry/brick, steel or timber frames, or are the panels to be used over existing plasterboard? These considerations will inform which fixing method is appropriate and what preparation may be required to prepare the space, and the tools required.

Openings and cut-outs

How many window or door openings appear within the project? Take note of any requirements to cut in GPO electrical outlets, air-conditioning vents or other similar attributes that will require panels to be pre-cut before fixing to the wall.

Internal and external corners

Planning for the joining of sheets and the overall layout will include noting where panels may be applied around an internal or external corner.

Full height panels or part height panels

- Will full height panels or partial height panels be installed?
- If using partial wall height panels, what paint or other finish will be used for the balance of the wall?
- Partial wall height panels may also require additional reinforcement and/or wall modifications to support the top of the panel.

Mouldings and dado rails

- If the use of mouldings and dado rails is anticipated, how high up the wall should they appear?
- Will they be interrupted by architraves on windows or doors?
- What is the optimum height to achieve an unbroken line where practical?

Mixing Surround by Laminex profiles on walls or ceilings

If more than one Surround by Laminex profile is being considered for the project, the appearance of the panels in both the height and the width of the wall or ceiling is important. The use of different profiles together is recommended with the addition of a dado rail or mould applied along the interface where the two profiles meet.

Measuring your space

Measure twice and cut once for the success of any project involving wood-based materials. It is vital that measurements are accurate for the correct ordering of panels and accessories. Pre-purchase estimating of Surround by Laminex panels should allow for expansion gaps of 5mm adjacent to any fixtures.

Prepare your panels

Surround by Laminex® is made from Medium Density Fibreboard (MDF). MDF responds to the humidity and temperature of the surrounding environment, affecting the moisture content of the product, resulting in panel dimensional change.

Surround by Laminex panels need to acclimatise for a minimum of 48 hours on-site before installation. This should be integrated into the ordering, delivery and project planning.

6.2 Fixing

Fixings should be carefully positioned to prevent splintering and breakout.

No face fixings are allowed less than 25mm to a corner or less than 10mm to an edge.

No edge fixings are allowed less than 75mm to a corner.

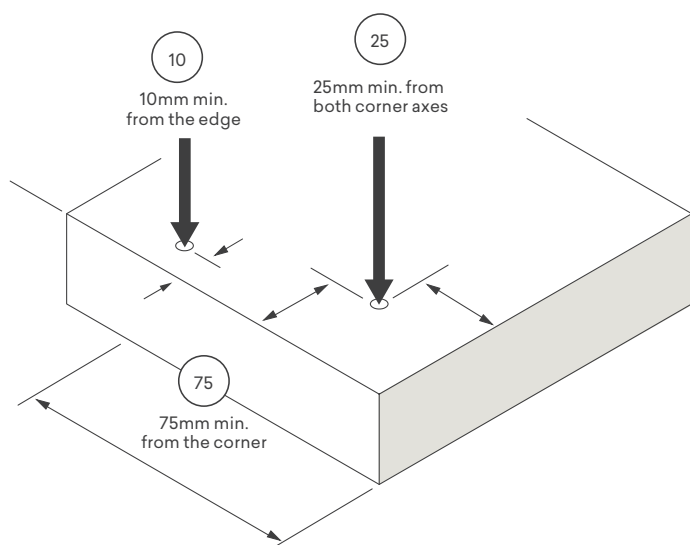

When applying fixings with power tools (nail gun, screw gun), only use enough pressure to drive the head of the nail or screw marginally below the surface of the panel. Splitting of the panel can occur if the pressure is too high or if the fixing is driven in too far and tooling marks will show on the finished surface.

6.2.1 Nails

Finishing nails provide better holding power than smooth nails. Driving nails in at an angle further increases the holding power. Drill a pilot hole to avoid splitting.

6.2.2 Screws

Parallel threaded screws are recommended for fixing Surround by Laminex panels.

To avoid splitting the panel when screwing into the panel edge the diameter of the screw selected for use should not exceed 20% of the panel thickness.

Pilot holes are recommended for use to avoid splitting. They should be drilled at least 2-3mm longer than the screw length to be used and be approximately 80% of the screw core diameter. Do not over tighten screws as further turning after screw is tight will reduce holding power and increase the risk of fracture or splitting of the panel.

When a long line of screws is used, it is recommended to stagger the screws to prevent splitting in the substrate being affixed to.

6.3 Expansion gaps and dimensional tolerance

Wall to floor interface

A minimum expansion gap of 5mm MUST be left between the top surface of the primary floor and the bottom edge of the Surround by Laminex® panel. Fixings of moulding / wall skirtings must maintain the unimpeded 5mm gap.

Wall to ceiling interface

A minimum expansion gap of 5mm MUST be left between the top edge of the Surround by Laminex panel and the primary ceiling. Fixings of a cornice or moulding must maintain the unimpeded 5mm gap.

Panel to panel interface

Surround by Laminex panels are supplied with a tongue and groove joining system.

Do not install adjacent panels without the supplied tongue.

A minimum 1.0mm to 1.5mm expansion gap MUST be allowed between each adjacent Surround by Laminex panel.

DO NOT “Hard Knock” adjacent panels into position.

Panel to fixture interface

A fixture is defined as any permanent structure affixed to the wall or ceiling, including architraves.

A minimum expansion gap of 5mm MUST be left between the edge of the Surround by Laminex panel and the fixture.

Full run wall expansion allowance

An allowance of 1mm expansion gap for every meter of horizontal wall length covered, MUST be allowed at the start and finish of each wall.

Example: A horizontal wall length of 7m will require an expansion gap of $7 \times 1\text{mm} = 7\text{mm}$ total gap allowance to be evenly applied to both ends of the wall. Hence, 3.5mm at the start and 3.5mm at the end of the wall installation.

- Ⓢ Any expansion gap allowance non-compliance will not be recognised under warranty.

6.4 Fixing to timber stud walls and/or steel framed walls

6.4.1 Preparing the wall

Studs must be spaced at no more than 600mm centres.

For commercial high traffic areas, studs must be spaced at no more than 450mm centres.

Where sheets will need to be joined between studs, place a noggin at 700mm to support the join.

If Surround by Laminex® panels are to be used for partial wall height installations, place a noggin just below the top edge of the panel for support.

Check that the frame is straight and true with a spirit level/laser level. Any amendment to a frame required to rectify irregularities, must be conducted by a qualified tradesperson.

Please refer to and comply with all expansion gap requirements.

For any application where 9mm Surround by Laminex panels are applied to the internal side of an externally facing wall, the back surface of the Surround by Laminex panel must be primed. This is to minimise moisture transfer from external environments.

6.4.2 Installing the sheets

Start from one corner of the installation and work across.

Apply generous amounts of construction adhesive on each stud/noggin behind each Surround by Laminex panel. It is recommended to follow the adhesive manufacturer's instructions for the amount to be used.

Ensure there is a 5mm expansion gap at the wall to floor interface. Material off-cuts or other spacers can be used as a removable prop to lift the Surround by Laminex panel off the floor.

Ensure there is a 5mm expansion gap at the wall to ceiling interface.

- Use a spirit level/laser level to ensure the Surround by Laminex panel is accurately placed onto the frame.
- Using nails or screws, fix the panels to the battens/furring channels. Space the nails/screws approximately 200mm to 300mm apart.
- Fix nails/screws 50mm from side and 10mm from top and bottom of the Surround by Laminex panel.
- It is important that a fixing pattern be followed. The fixing should work from the centre out in every direction. If this is not possible on larger panels, fix along one side first and then work across the panel on all patterns evenly.
- Remove the spacer from the bottom of the Surround by Laminex® panel.
- Fix the other panels using the same method outlined above, working along the wall from the first panel.
- Make sure you leave a 1.0mm to 1.5mm gap at each join to allow for expansion of the panels.
- When you get close to the corner or a doorway, measure the gap from the fixed panel to the corner and cut the next panel so that it fits the remaining space. Fix the panel using the same method as described above.
- Do not hard knock panels together.

Timber or steel frames – Full wall

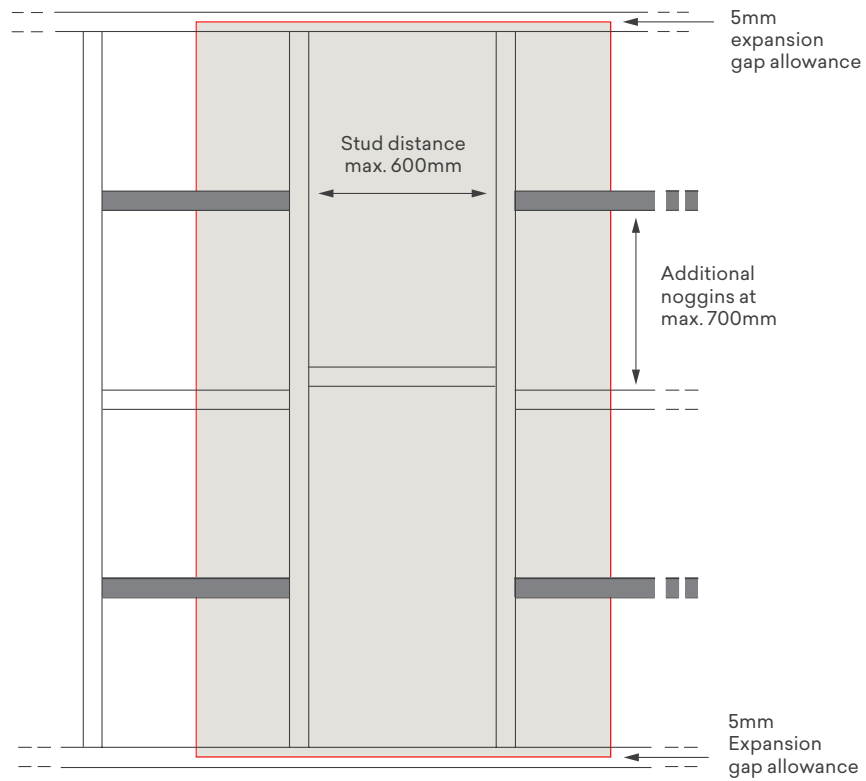
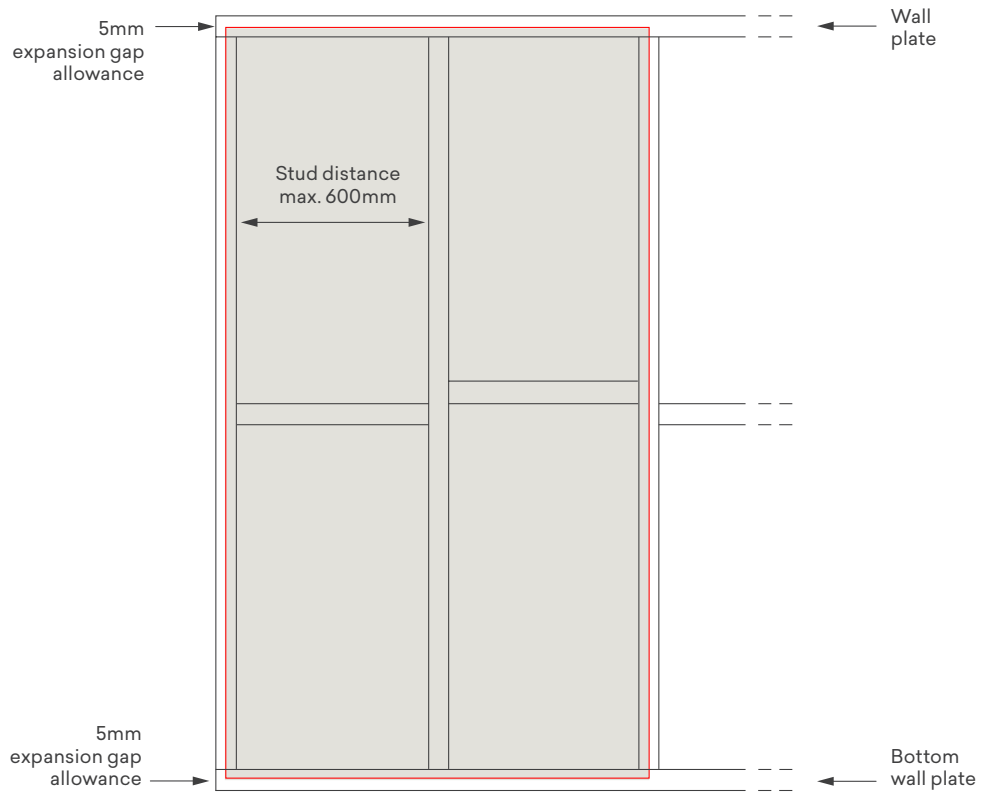

Surround by Laminex® panel

NOTE: Extra noggins not required when full panels are joined on studs.

Additional Noggin

NOTE: Extra noggins required when full panel joins are NOT on studs.

6.5 Fixing to plasterboard

6.5.1 Checking and preparing the wall frame behind the plasterboard

When installing Surround by Laminex® on an existing wall, it is vital that the studs are located. The studs are to be used as fixing points during installation.

Studs must be spaced at no more than 600mm centres. Ensure the studs are checked using a stud finder to locate and ensure suitability of the underlying wall frame.

Where sheets will need to be joined between studs, place a noggin at 450mm to support the join. This will require a disruption of the existing plasterboard surface. Please consult with a qualified tradesperson as required for this process. Caution should be taken not to impact or disrupt electrical wiring, plumbing or other services within the wall. Only qualified tradespeople should be involved in any modifications that are required to internal wall cavities.

6.5.2 Installing the sheets

Start from one corner of the installation and work across.

Apply generous amounts of construction adhesive in the location of each stud/noggin behind each Surround by Laminex panel. It is recommended to follow the adhesive manufacturer's instructions for the amount to be used.

Ensure there is a 5mm expansion gap at the wall to floor interface. Material off-cuts or other spacers can be used as a removable prop to lift the Surround by Laminex panel off the floor.

Ensure there is a 5mm expansion gap at the wall to ceiling interface.

- Use a spirit level/laser level to ensure the Surround by Laminex panel is accurately placed onto the frame.
- Using nails or screws, fix the panels to the battens/furring channels. Space the nails/screws approximately 200mm to 300mm apart.
- Fix nails/screws 50mm from side and 10mm from top and bottom of the Surround by Laminex panel.
- It is important that a fixing pattern be followed. The fixing should work from the centre out in every direction. If this is not possible on larger panels, fix along one side first and then work across the panel on all patterns evenly.
- Remove the spacer from the bottom of the Surround by Laminex panel.
- Fix the other panels using the same method outlined above, working along the wall from the first panel.
- Make sure you leave a 1.0mm to 1.5mm gap at each join to allow for expansion of the panels.
- When you get close to the corner or a doorway, measure the gap from the fixed panel to the corner and cut the next panel so that it fits the remaining space. Fix the panel using the same method as described above.
- Do not hard knock panels together.

Existing Wall – Full Wall

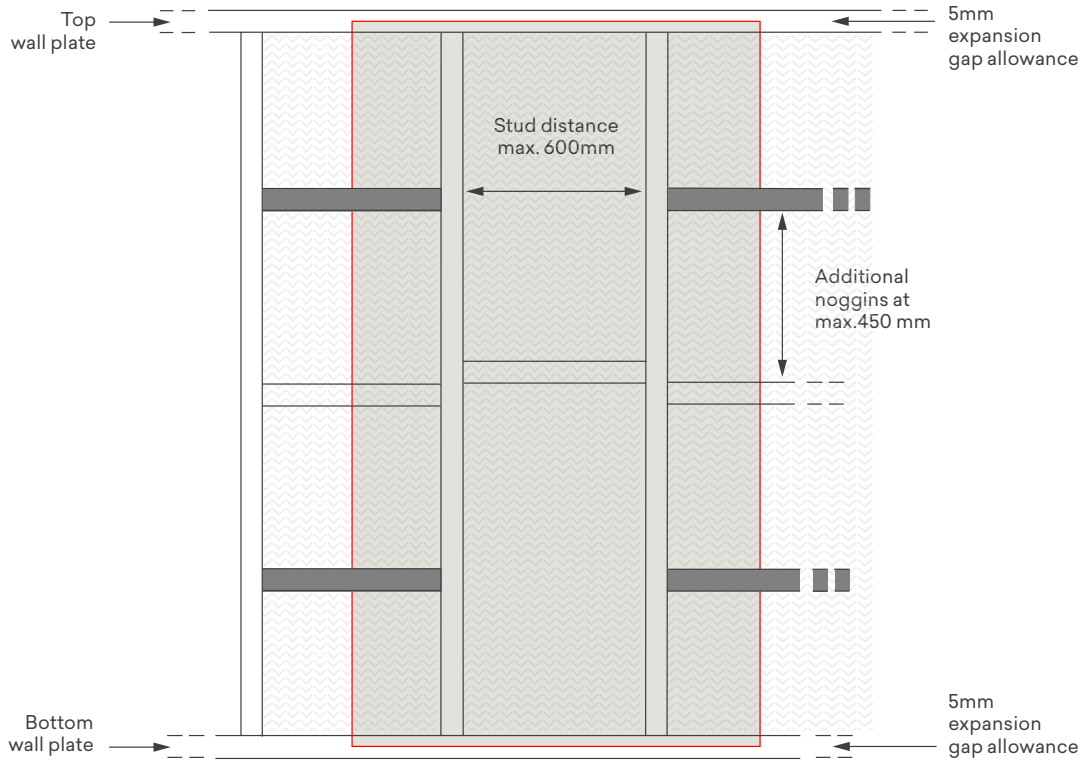
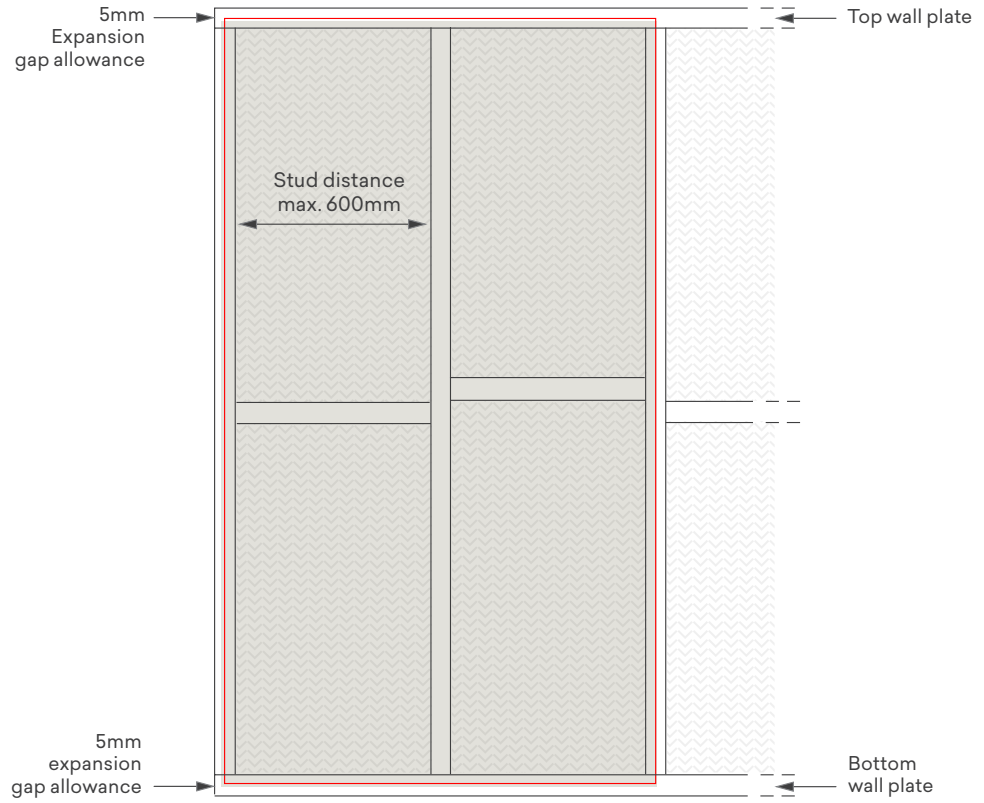

Surround by Laminex® panel

NOTE: Extra noggins not required when full panels are joined on studs.

Additional Noggin

NOTE: Extra noggins required when full panel joins are NOT on studs.

6.6 Fixing to brick and block walls or masonry

6.6.1 Preparing the wall

Battens or furring channels (a hat shaped corrosion resistant framing batten used to furr/flatten and smooth out masonry wall assemblies) should be employed. Fasten battens or channels to the brick wall surface using concrete nails or power-driven fasteners per instructions supplied with the fixings.

The battens/furring channels should be fitted horizontally at approximately 450mm apart to promote airflow behind the Surround by Laminex® panels.

Ⓜ Direct fixing to brick, block work or masonry is not permitted and will not be recognised under warranty.

If Surround by Laminex panels are to be used for partial wall height installations, place a noggin just below the top edge of the panel for support.

Check that battens/furring channels are straight and true with a spirit level/laser level and amend any irregularities.

Please refer to and comply with all expansion gap requirements.

For any application where 9mm Surround by Laminex panels are applied to the internal side of an externally facing wall, the back surface of the Surround by Laminex panel must be primed. This is to minimise moisture transfer from external environments.

6.6.2 Installing the sheets

Start from one corner of the installation and work across.

Apply generous amounts of construction adhesive on each batten/furring channel behind each Surround by Laminex® panel. It is recommended to follow the adhesive manufacturer's instructions for the amount to be used.

Ensure there is a 5mm expansion gap at the wall to floor interface. Material off-cuts or other spacers can be used as a removable prop to lift the Surround by Laminex panel off the floor.

Ensure there is a 5mm expansion gap at the wall to ceiling interface.

- Use a spirit level/laser level to ensure the Surround by Laminex panel is accurately placed onto the frame.
- Using nails or screws, fix the panels to the battens/furring channels. Space the nails/screws approximately 500mm apart.
- Fix nails/screws 50mm from side and 10mm from top and bottom of the Surround by Laminex panel.
- It is important that a fixing pattern be followed. The fixing should work from the centre out in every direction. If this is not possible on larger panels, fix along one side first and then work across the panel on all patterns evenly.
- Remove the spacer from the bottom of the Surround by Laminex panel.
- Fix the other panels using the same method outlined above, working along the wall from the first panel.
- Make sure you leave a 1.0mm to 1.5mm gap at each join to allow for expansion of the panels.
- When you get close to the corner or a doorway, measure the gap from the fixed panel to the corner and cut the next panel so that it fits the remaining space. Fix the panel using the same method as described above.
- Do not hard knock panels together.



Timber or steel frames – Partial wall

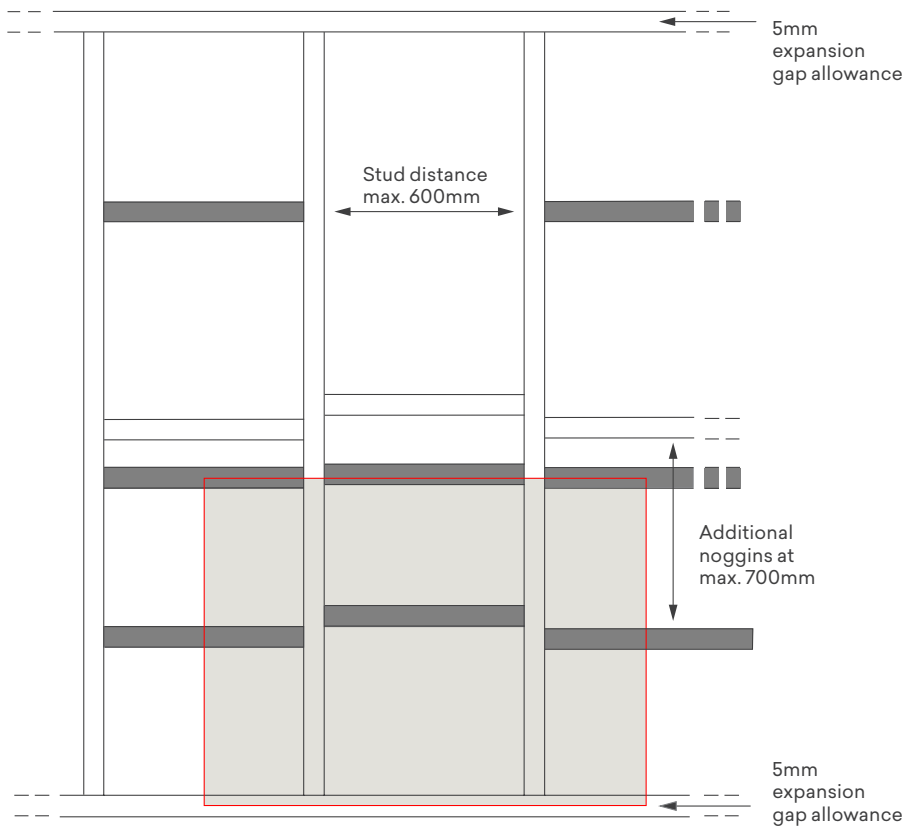
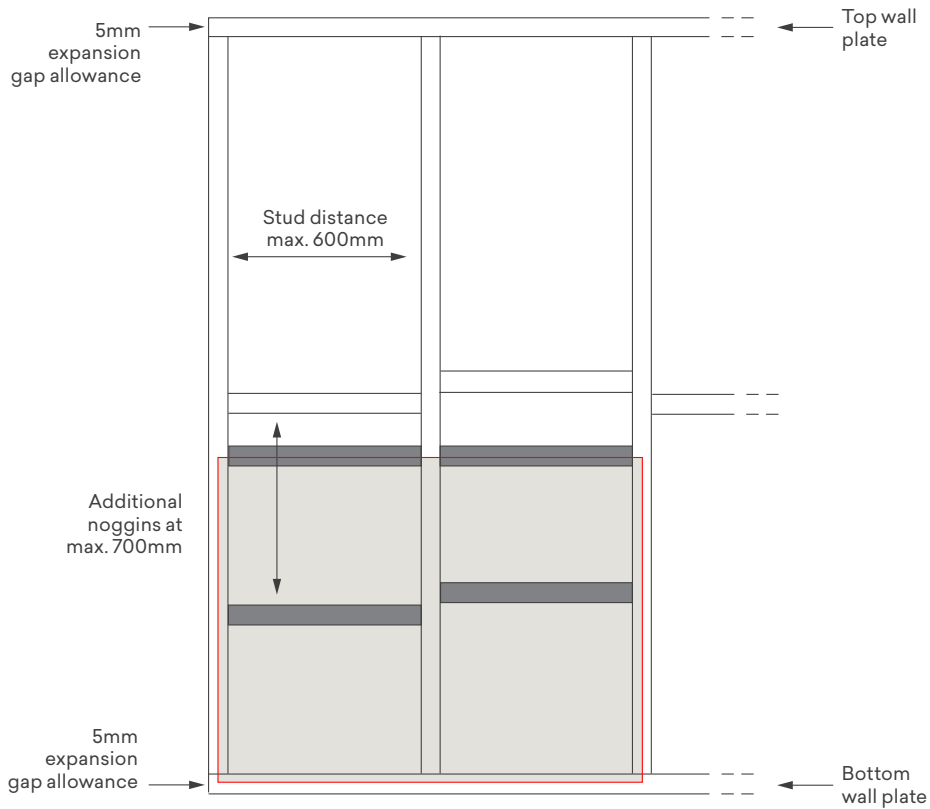

Surround by Laminex® panel

NOTE: Extra noggins not required when full panels are joined on studs.

Additional Noggin

NOTE: Extra noggins required when full panel joins are NOT on studs.

6.7 Installation in a horizontal orientation on walls

Installing sheets Horizontally utilises the same methods of installation for the wall substrates as described in the previous sections with additional focus given to the following:

6.7.1 Planning join locations

The location of joins in horizontal applications for Surround by Laminex® panels is more critical as these potentially need to be larger, depending upon the total length of the wall. Joining two 3000mm panels together on a 6000mm wall, then a 5mm minimum gap is required between the panels and at the end of each panel - or at junctions to window and door frames.

The vertical ends of horizontally installed panels do not have the integrated joining tongue and groove system. An alternative form of join should be used such as an expressed or negative details, or overlaid trims like dado rails can be used. The join method must allow for panel movement.

The location of the join should therefore be located centrally on the wall or place the main panel centrally to the wall, with cut panels either side in equal proportions to ensure a balanced look is achieved.

The ends of the panels should be supported by additional wall studs or battens if a frame wall, or adhesive if directly sticking to sheeted or plasterboard walls.

Horizontal joins are aligned by the tongue and groove system. This join should be supported by noggings to protect the join from impact movement.

6.7.2 Installation

Install the base level panels first. Use a spirit level or laser level to ensure the panels are level. Use spacing blocks on the floor to allow for the panel to be levelled while providing the 5mm expansion gap at the junction with the floor.

- Once level, and the joins correctly located, using nails or screws, fix the panels to the battens/furring channels. Space the nails/screws approximately 200mm to 300mm apart.
- Fix nails/screws 50mm from side and 10mm from top and bottom of the Surround by Laminex® panel.
- It is important that a fixing pattern be followed. The fixing should work from the centre out in every direction. If this is not possible on larger panels, fix along one side first and then work across the panel on all patterns evenly.
- Remove the spacer from the bottom of the Surround by Laminex panel.
- The next level or panels can now be placed into position using the tongue and groove system to align the joins. Do not force these joins tightly together - they are designed to allow the panels to move.
- Fix the other panels using the same method outlined above.
- The vertical expansion gaps should be maintained, ensuring these are not stepped and evenly spaced preserving the expansion gap.
- When you get close to the corner or a doorway, measure the gap from the fixed panel to the corner and cut the next panel so that it fits the remaining space. Fix the Surround by Laminex panel using the same method as described above.

Horizontal orientation on walls

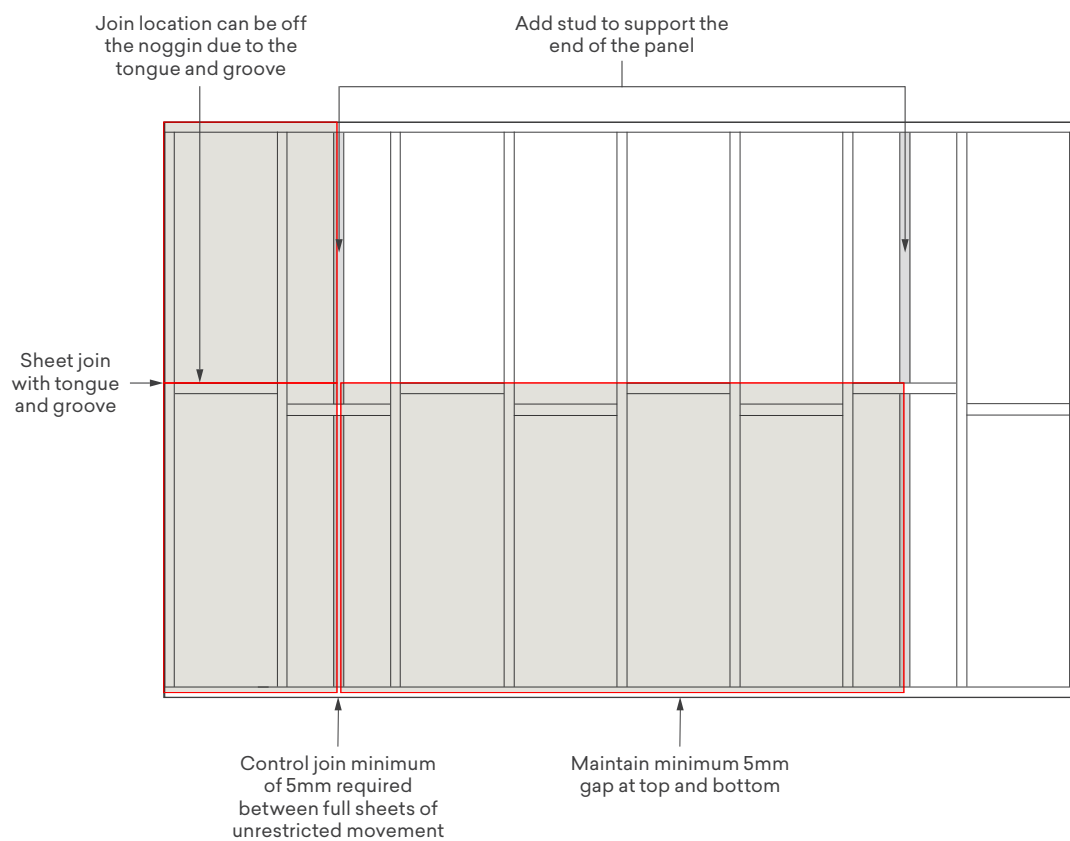

Ⓜ Use of butt joints between panels ends will not be recognised under warranty.

6.8 Installation in Internal Moisture Areas

DISCLAIMER: Surround by Laminex® Wall Panels **CANNOT** be installed in:

- Direct 'Splash Zones'. This includes showers or in any application where a vessel (bath, tapware or basin) is within 75mm of the wall.
- Areas where the moisture content is likely to be elevated for prolonged periods, such as saunas, indoor swimming pools or industrial wet areas.

Surround by Laminex as a Fire Resistant (E1 MDF FR) substrate is prohibited for use in Internal Moisture Areas.

Surround by Laminex MR E0 MDF Wall Panels **CAN** be installed on all other walls within bathrooms, kitchens and laundries, so long as the installation complies and is in accordance with NZBC E3 AS/1 or NZBC E3/AS2.

6.8.1 Fixing to plasterboard walls

When installing Surround by Laminex on an existing wall, it is vital that the studs are located. The studs are to be used as fixing points during installation. As this is an existing wall, studs should be placed at no greater than 600mm centres.

Ensure the studs are located using a stud finder and ensure suitability of the underlying wall frame. Stud and noggin locations should accommodate proposed location of plumbing and fixings. Heavy items should not be directly attached to the Surround by Laminex wall surface without support from the wall studs.

In some cases, the removal of tiles will have resulted in damage or partial removal of the existing plasterboard. This will require a disruption of the existing plasterboard surface. Please consult with qualified trades as required for this process. Caution should be taken not to impact or disrupt electrical wiring, plumbing or other services within the wall. Only qualified tradespeople should be involved in any modifications that are required to internal wall cavities.

In some cases, the existing wall may have been removed all together. Please refer to section 6.8.2 for further instructions on the installation of Surround by Laminex directly on to a stud wall.

It is extremely important that all substrate (MDF) edges – including cut-outs such GPO's (electrical outlets) are sealed appropriately and effectively. This can be done by applying at least one coat of primer and two coats of acrylic topcoat paint prior to being exposed to any area where moisture may be present.

Once the spacing and joint location has been planned, which may necessitate the first sheet being cut, start from one corner of the installation and work across.

Penetration through Surround by Laminex panels to accommodate **taps or spouts of any description is expressly prohibited.**

Claims resulting from failure to adequately seal all exposed edges **will not be recognised.**

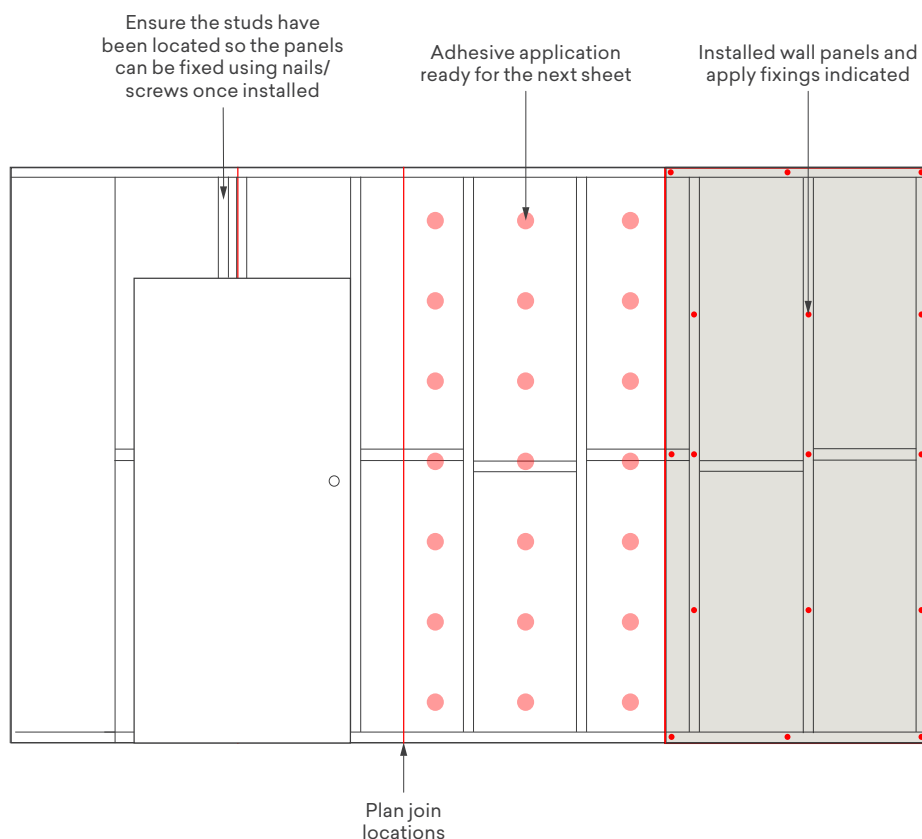

Apply generous amounts of construction adhesive behind each Surround by Laminex® panel. It is recommended to follow the adhesive manufacturer's instructions for the amount to be used.

Ensure there is a 5mm expansion gap at the wall to floor interface. Material off-cuts or other spacers can be used as a removable prop to lift the Surround by Laminex panel off the floor.

- Use a spirit level or laser level to ensure the Surround by Laminex panel is accurately placed onto the wall.
- Using nails or screws, fix the panels to the battens/furring channels. Space the nails/screws approximately 200mm to 300mm apart.
- Fixings should not be closer than 100mm from top and bottom or 50mm from the edge of the panels.
- It is important that a fixing pattern be followed. The fixing should work from the centre out in every direction. If this is not possible on larger panels, fix along one side first and then work across the panel on all patterns evenly.
- Remove the spacer from the bottom of the Surround by Laminex panel.
- Fix the other panels using the same method outlined above, working along the wall from the first panel.
- Make sure you leave a 1.0mm to 1.5mm gap at each join to allow for expansion of the panels.
- When you get close to the corner or a doorway, measure the gap from the fixed panel to the corner and cut the next panel so that it fits the remaining space. Fix the panel using the same method as described above.
- Do not hard knock panels together.

Once installed it is extremely important to ensure all gaps around the panels are sealed so moisture is not exposed to edges and the rear side of the Surround by Laminex panels.

6.8.2 Fixing to timber stud walls and/or steel framed walls

Studs must be spaced at no more than 600mm centres.

For commercial high traffic areas, studs must be spaced at no more than 450mm centres.

Where sheets will need to be joined between studs place a noggin at 700mm to support the join.

If Surround by Laminex® panels are to be used for partial wall height installations, place a noggin just below the top edge of the panel for support.

Check that the frame is straight and true with a spirit level or laser level. Any amendment to a frame required to rectify irregularities, must be conducted by a qualified tradesperson.

Please refer to and comply with all expansion gap requirements.

For any application where 9mm Surround by Laminex panels are applied to the internal side of an externally facing wall, the back surface of the Surround by Laminex panel must be primed. This is to minimise moisture transfer from external environments.

It is extremely important that all substrate (MDF) edges – including cut-outs such GPO's (electrical outlets) - are sealed appropriately and effectively. This can be done by applying at least one coat of primer and two coats of acrylic topcoat paint prior to being exposed to any area where moisture may be present.

Once the spacing and joint location has been planned, which may necessitate the first sheet being cut, start from one corner of the installation and work across.

Penetration through Surround by Laminex panels to accommodate taps or spouts of any description is expressly prohibited.

Claims resulting from failure to adequately seal all exposed edges **will not be recognised.**

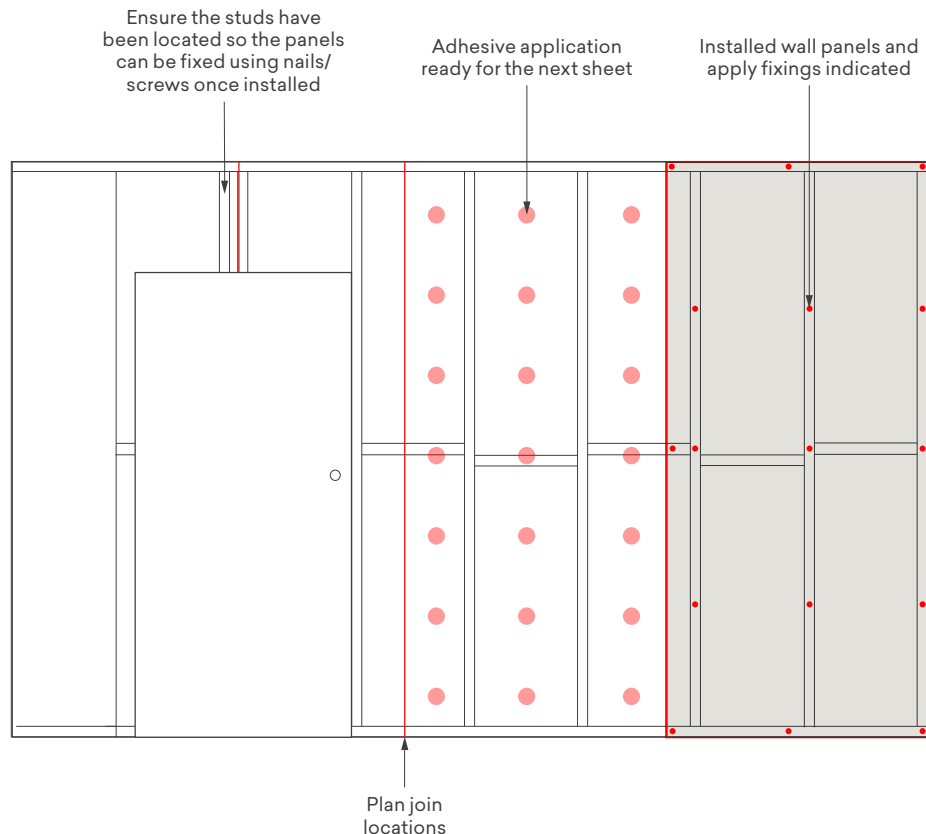

Apply generous amounts of construction adhesive on each stud/noggin behind each Surround by Laminex® panel. It is recommended to follow the adhesive manufacturer's instructions for the amount to be used.

Ensure there is a 5mm expansion gap at the wall to floor interface.

Material off-cuts or other spacers can be used as a removable prop to lift the Surround by Laminex panel off the floor.

Ensure there is a 5mm expansion gap at the wall to ceiling interface.

- Use a spirit level or laser level to ensure the Surround by Laminex panel is accurately placed onto the frame.
- Using nails or screws, fix the panels to the battens/furring channels. Space the nails/screws approximately 200mm to 300mm apart.
- Fix nails/screws 50mm from side and 10mm from top and bottom of the Surround by Laminex panel.
- It is important that a fixing pattern be followed. The fixing should work from the centre out in every direction. If this is not possible on larger panels, fix along one side first and then work across the panel on all patterns evenly.
- Remove the spacer from the bottom of the Surround by Laminex panel.
- Fix the other panels using the same method outlined above, working along the wall from the first panel.
- Make sure you leave a 1.0mm to 1.5mm gap at each join to allow for expansion of the panels.
- When you get close to the corner or a doorway, measure the gap from the fixed panel to the corner and cut the next panel so that it fits the remaining space. Fix the panel using the same method as described above.
- Do not hard knock panels together.

Once installed, it is extremely important to ensure all gaps around the panels are sealed so moisture is not exposed to the rear side of the panels.

6.8.3 Fixing to brick and block walls or masonry

When installing Surround by Laminex in Internal Moisture Areas over brick, block or masonry walls, refer to section 6.6 for wall preparation.

6.8.4 Painting Panels in Internal Moisture Areas

Prior to installing Surround by Laminex wall panels in Internal Moisture Areas, all edges and the front surface **MUST** be completely sealed with a sealer primer undercoat. This includes cut-outs for GPO's (electrical outlets). Surround by Laminex faces should have at least two coats of acrylic topcoat paint, or as advised by the paint manufacturer.

To avoid cracking or warping, in areas exposed to full sunlight, dark colour paints should not be used. The light reflective value (LRV) should be 50% or more for interior applications. The paint manufacturer can provide LRV detail of the paint being applied.



Always use high quality paint and follow the paint manufacturers' preparation and application instructions including the amount of coats required. For the best finish, low gloss or satin finish paints are recommended.

Your Laminex Surround panels will experience "normal wear and tear" – regular maintenance checks of Surround by Laminex product should be performed, make minor remedial and or painting repairs as required.

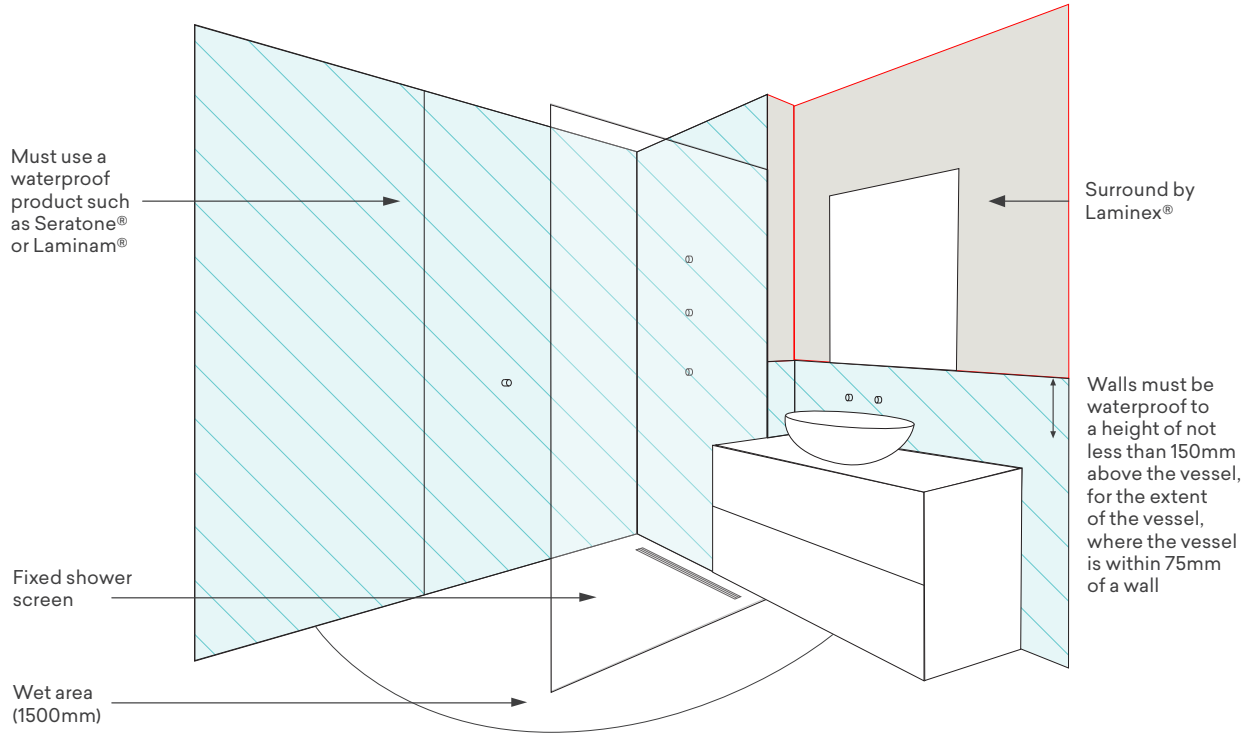
Open Shower



Key



-  Splash Zone (Waterproofing Required)
-  Surround by Laminex® Panels

Surround by Laminex® panels MUST NOT BE located where they will get wet - i.e. in a Splash Zone. Fire Resistant (E1 MDF FR) substrate product is prohibited for use in Internal Moisture Areas.

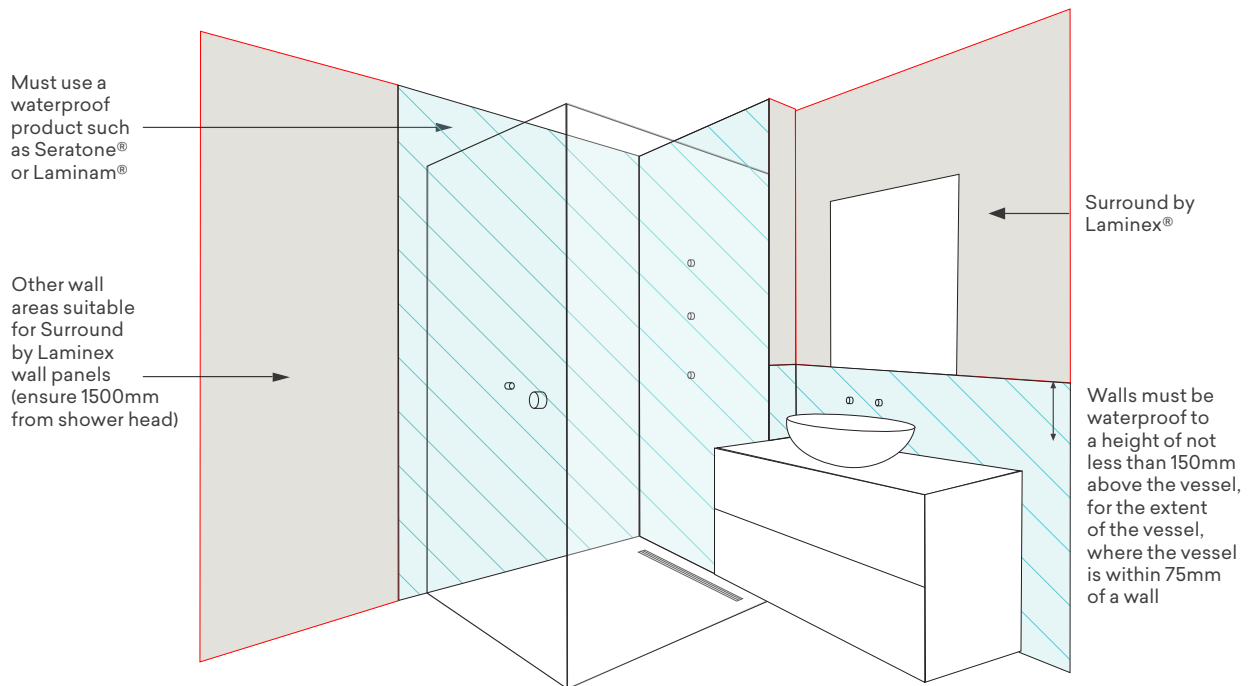
Enclosed Shower



Key



-  Splash Zone (Waterproofing Required)
-  Surround by Laminex® Panels

Surround by Laminex® panels MUST NOT BE located where they will get wet - i.e. in a Splash Zone. Fire Resistant (E1 MDF FR) substrate product is prohibited for use in Internal Moisture Areas.

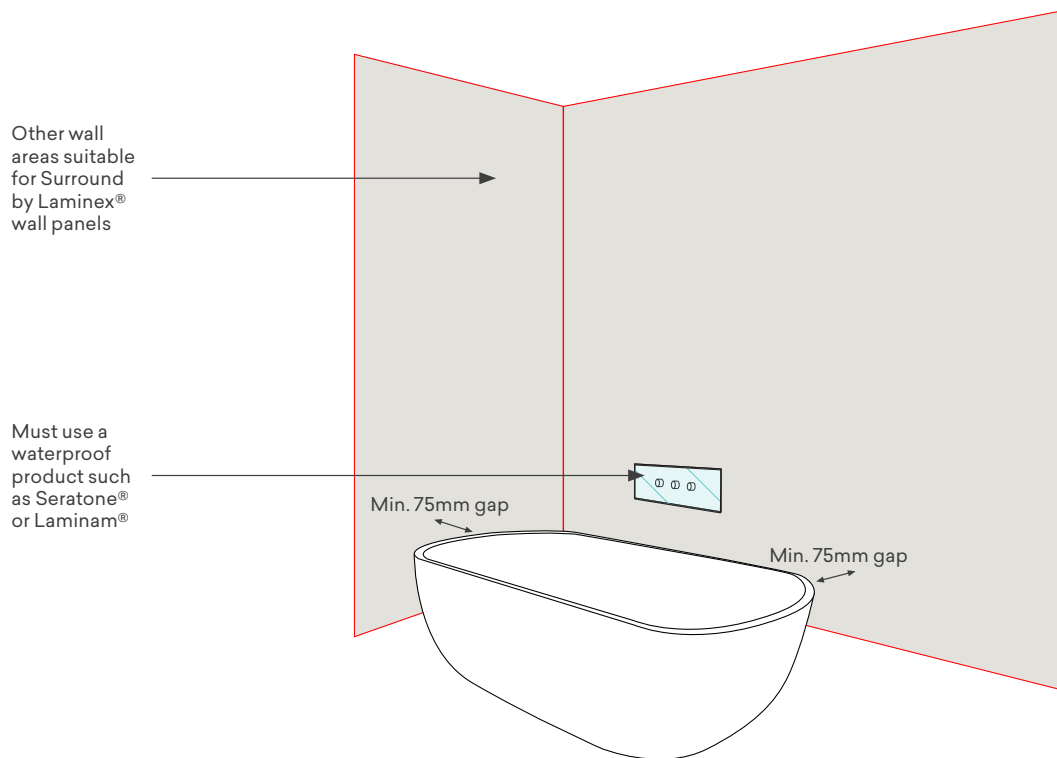
Bath – free standing



Key



-  Splash Zone (Waterproofing Required)
-  Surround by Laminex® Panels

Surround by Laminex® panels MUST NOT BE located where they will get wet - i.e. in a Splash Zone. Fire Resistant (E1 MDF FR) substrate product is prohibited for use in Internal Moisture Areas.

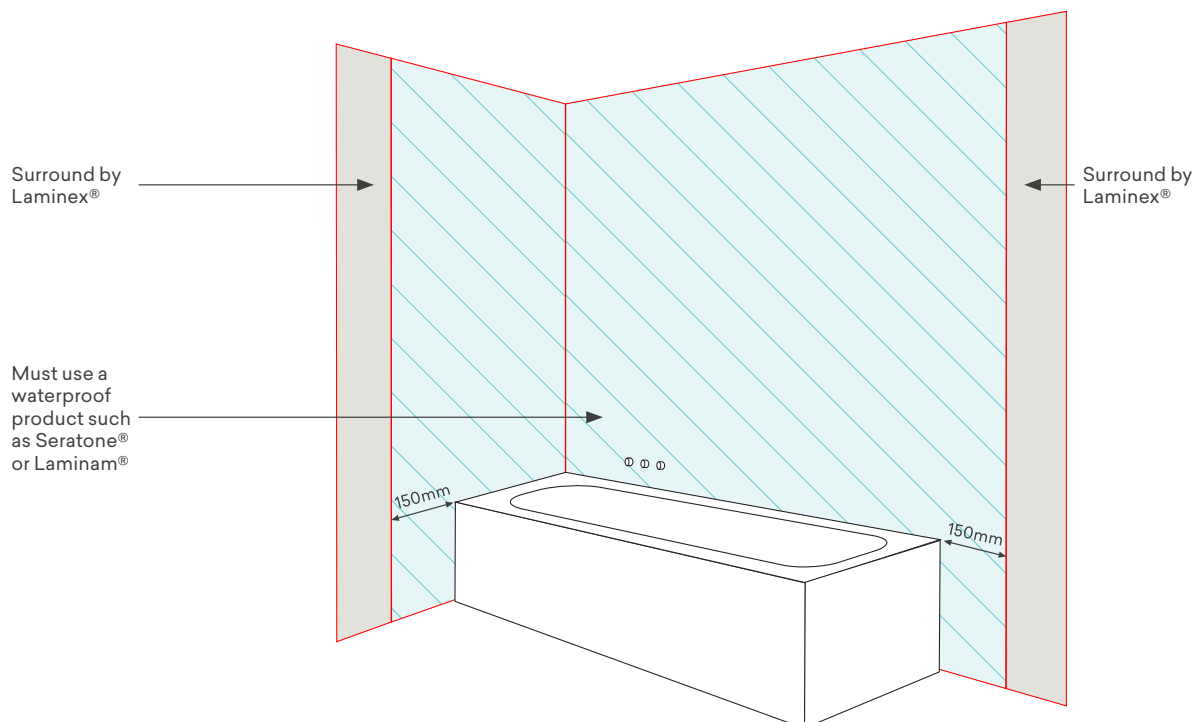
Bath – fixed



Key

-  Splash Zone (Waterproofing Required)
-  Surround by Laminex® Panels

Surround by Laminex® panels MUST NOT BE located where they will get wet - i.e. in a Splash Zone. Fire Resistant (E1 MDF FR) substrate product is prohibited for use in Internal Moisture Areas.

Shower over bath

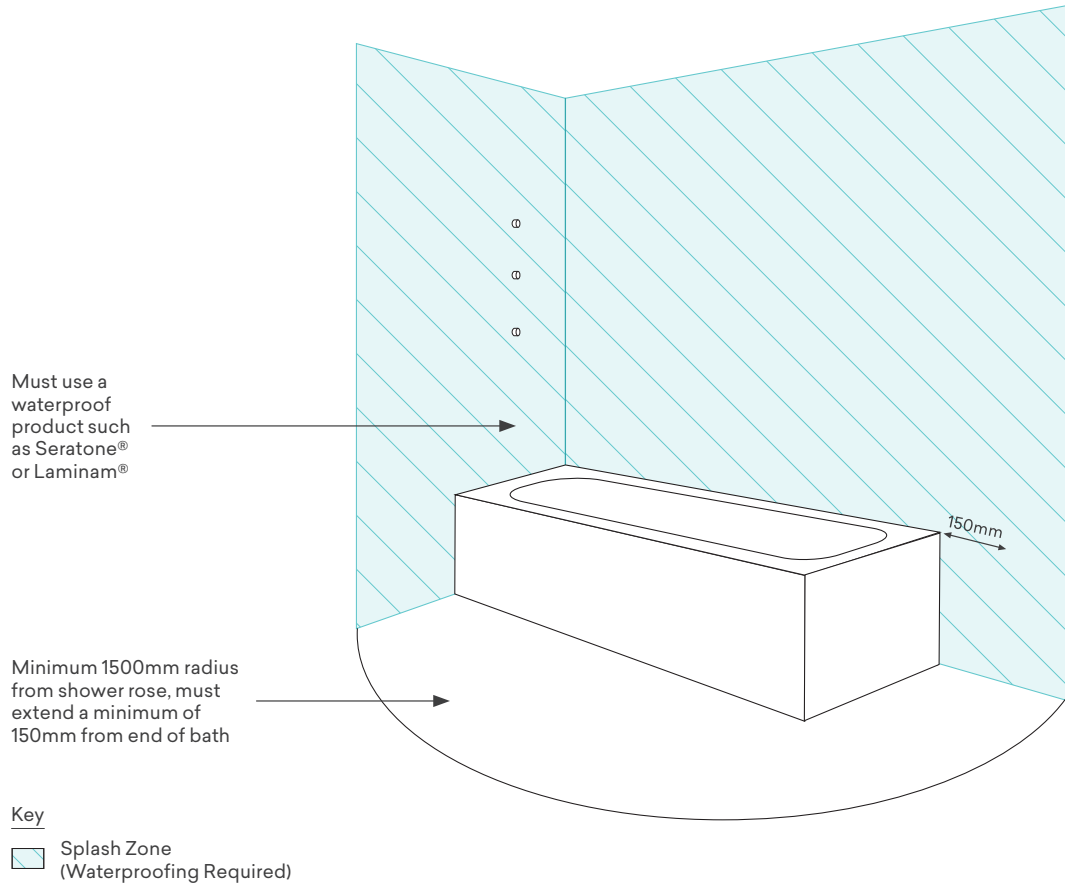

Surround by Laminex® panels MUST NOT BE located where they will get wet - i.e. in a Splash Zone.
Fire Resistant (E1 MDF FR) substrate product is prohibited for use in Internal Moisture Areas.

Vanity



Other wall areas suitable for Surround by Laminex® wall panels

Must use a waterproof product such as Seratone® or Laminam®

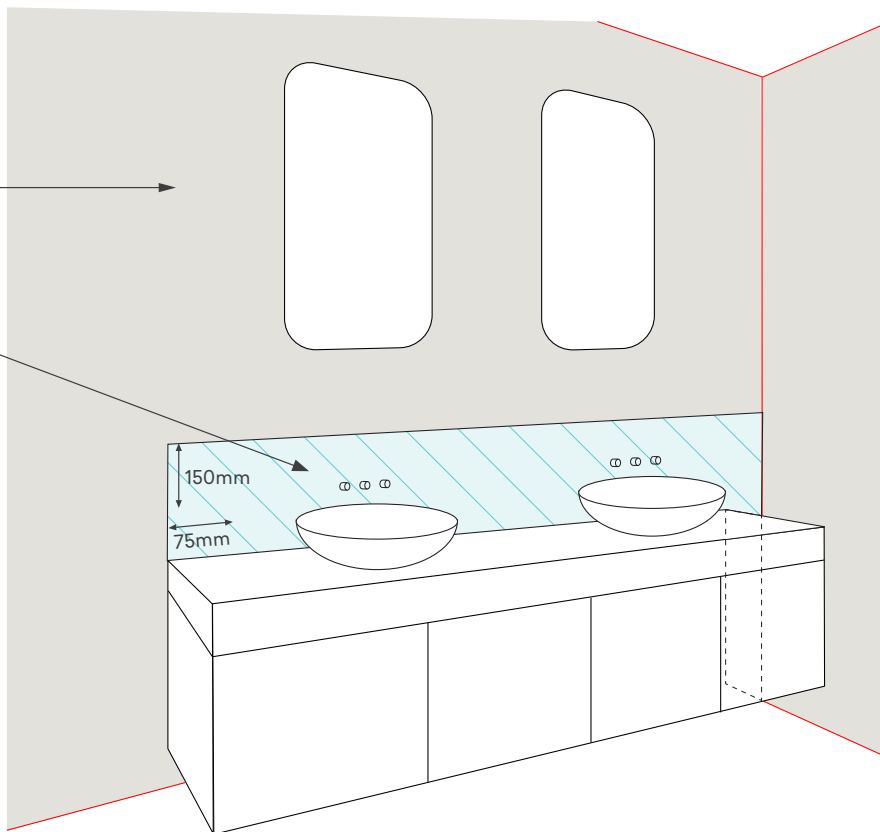
Walls must be waterproof to a height of not less than 150mm above the vessel, for the extent of the vessel, where the vessel is within 75mm of a wall



Key

-  Splash Zone (Waterproofing Required)
-  Surround by Laminex® Panels

Surround by Laminex® panels MUST NOT BE located where they will get wet - i.e. in a Splash Zone. Fire Resistant (E1 MDF FR) substrate product is prohibited for use in Internal Moisture Areas.

Laundry / Kitchen

Other wall areas suitable for Surround by Laminex® wall panels



Tiles behind the tub and taps/spout and cover the splash zone

Must use a waterproof product such as Seratone® or Laminam®

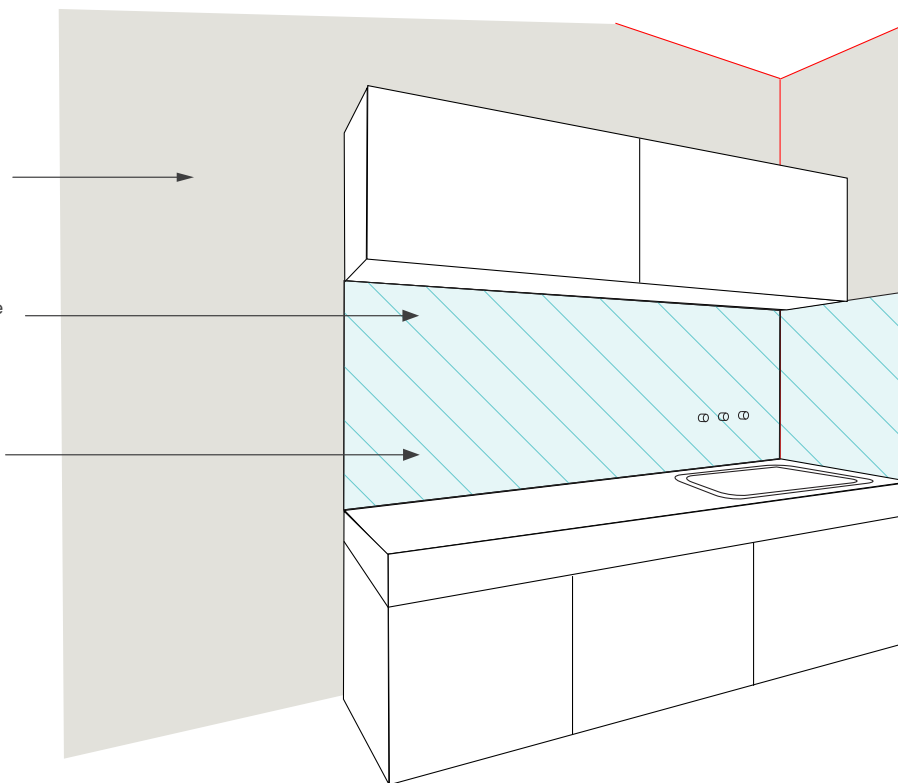
Walls must be waterproof to a height of not less than 150mm above the vessel, for the extent of the vessel, where the vessel is within 75mm of a wall



Key

-  Splash Zone (Waterproofing Required)
-  Surround by Laminex® Panels

Surround by Laminex® panels MUST NOT BE located where they will get wet - i.e. in a Splash Zone. Fire Resistant (E1 MDF FR) substrate product is prohibited for use in Internal Moisture Areas.

6.9 Installation on ceilings

Surround by Laminex® panels can be installed in a standard ceiling with truss and batten construction.

6.9.1 Planning and installation

- Ensure the ceiling structure is straight and level.
- Ceiling battens must be placed at intervals of 450 mm or less.
- Plan how you will finish internal and external corners before starting the installation.
- DO NOT END BUTT panels as they may lead to ongoing movement; use a cover mould or bulkhead design instead.
- Classic VJ 100 is available in 9mm thick with no white backer on the panel, so priming on the back face is required.
- All other profiles are only available in 12mm thickness with a white backer, so no priming on the back face is required.
- If the joists are spaced at 450mm or less, the panels can be installed directly onto them.
- When using a powered saw, cut with the face side down. When using a handsaw, cut with the face side up. If using a powered saw, refer to the manufacturing guidelines for directional cutting.
- Leave a 5mm expansion gap around the perimeter of each room's ceiling.
- Allow a 1.0mm to 1.5mm expansion gap at each joint between panels.
- If joining off the battens, support any joins with additional noggins spaced no more than 700mm apart where required.
- Surround by Laminex panels are a timber-based product. Care should be taken when installing to manage the moisture environment from the adjacent air conditioning plant and pipe works. Refer to section 6.8 in this manual for Internal Moisture Area installations (e.g. bathrooms, laundries, and kitchens).

- Ⓜ Penetration through Surround by Laminex panels to accommodate light fittings, shower fittings, ducts, and vents of any description, should be sealed to prevent moisture ingress to the panel and prevent leakage behind the panels. Recess shower heads into the surface of Surround by Laminex ceiling panels is not a warrantable application.

DISCLAIMER: Surround by Laminex Wall Panels cannot be installed in direct 'Splash Zones'. This includes showers or in any application where a vessel (bath, tapware or basin) is within 75mm of the wall. However, Surround by Laminex Wall Panels can be installed on all other walls within bathrooms and laundries, so long as the installation complies and is in accordance with NZBC E3 AS/1 or NZBC E3/AS2. Fire Resistant product (E1 MDF FR) is prohibited for use in Internal Moisture Areas.

For additional information, refer to section 6.8 - 'Installation in Internal Moisture Areas.'

- Ⓜ Claims resulting from failure to adequately seal all exposed edges will not be recognised.

Consumables

Anti-rust parallel threaded screws to fix Surround by Laminex® panels to the ceiling. Make sure they penetrate the battens at least 25-30mm. Consider self-drilling and countersunk screws.

Flexible construction adhesive to glue the panels to the battens. Ensure the adhesives allow 25% movement capability. We recommend Sikaflex® 123 MS Bond, Gorilla 240FC and Gorilla MS Bond.

It is recommended timber putty filler is on hand to cover fixings.

PVA adhesive is recommended for fixing any timber moulding and trims used in combination with Surround by Laminex panels.

For tooling, refer to section 5.1 - 'Tools and equipment'.

Cutting instructions

Surround by Laminex panels can be readily cut with a powered saw or hand saw. New or sharpened blades should always be used as blunt or dull blades will decrease the accuracy and finish of cuts.

Surround by Laminex panels should be cut only on saws that have a scribing blade on the underside.

When using a powered saw, cut the panels with the decorative face down and when using a handsaw cut the panels with the decorative face side up.

It is recommended that a test piece be cut to verify the correct decorative face position for the specific cutting equipment to be used.

If using a router, do not allow the cutter to take too deep a cut at a time and only trench a maximum of one-third of the thickness, per pass.

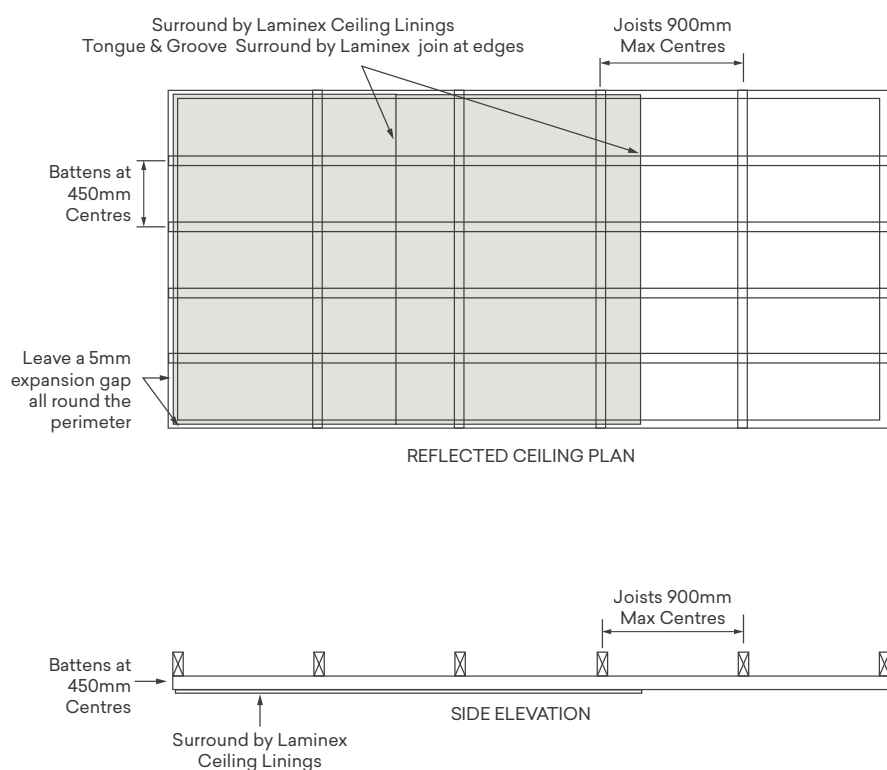

Note: Maximum 900mm joist / rafter / truss centres for fixing ceiling battens / furring channels where the roof design allows for this.

Preparing the ceiling

Any modification required to the structural framework must be conducted by a qualified Tradesperson.

Ensure that the ceiling structure is straight and level. Rectify any irregularities or defects.

Install battens across the ceiling trusses, maintaining a spacing of 450mm or less between them.

Preparing the Surround by Laminex® panels

Allow the sheets to achieve “moisture content equilibrium (MCE)” in the area where they will be installed for 24 to 48 hours before proceeding with the installation.

Painting and finishing

- Please refer to section 6.8.4 - ‘Painting panels in Internal Moisture Areas’.
- Please refer to section 7.1 – ‘Painting’.

6.9.2 Installing the panels

Laminex New Zealand® recommends installing the sheets across the ceiling battens.

Begin the installation from one side of the room, working systematically across the entire ceiling.

To install panels on the ceiling, begin by applying flexible construction adhesive at 600mm intervals on each batten and any noggins behind the first sheet. Ensure that you follow the recommended quantity specified by the adhesive manufacturer. Continue this process for each subsequent sheet working along the ceiling from one side to the other.

Next, position the first panel, keeping in mind any out-of-square battens.

Use nails or screws to fix the panel to the ceiling battens. Ensure screw or nail holes are filled with solid filler before painting.

Fixings should be carefully positioned to prevent splintering and breakout.

No face fixings are allowed less than 25mm to a corner or less than 10mm to an edge.

No edge fixings are allowed less than 75mm to a corner.

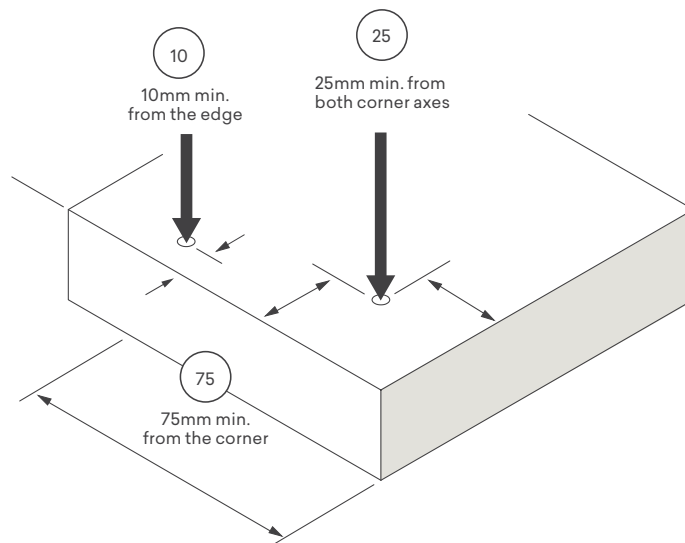

Use a spirit level to ensure that the panel is level and adjust it as necessary using screws. The adhesive will help bridge any gaps between the panel and the batten.

Screws or nails are spaced approximately 400mm apart to secure the sheet to the battens, ensuring that the fixings penetrate the battens by at least 30mm.

Repeat this process to fix the remaining sheets, progressing from one side of the ceiling to the other.

Leave a 1.0mm to 1.5mm gap at each sheet joint to allow for sheet expansion.

For the final panels, measure the remaining space and cut the sheet 5mm shorter than the gap to be filled.

If an existing ceiling is in place, it is important that Surround by Laminex® should be fixed to the ceiling battens or joists. Failure to secure the primary ceiling structure may result in panels dislodging where they are secured only to the ceiling substrate. This outcome is dangerous to the occupants of the room and must be avoided.

Ⓜ Failure to secure the Surround by Laminex panels to the primary ceiling structure will not be recognised under warranty.

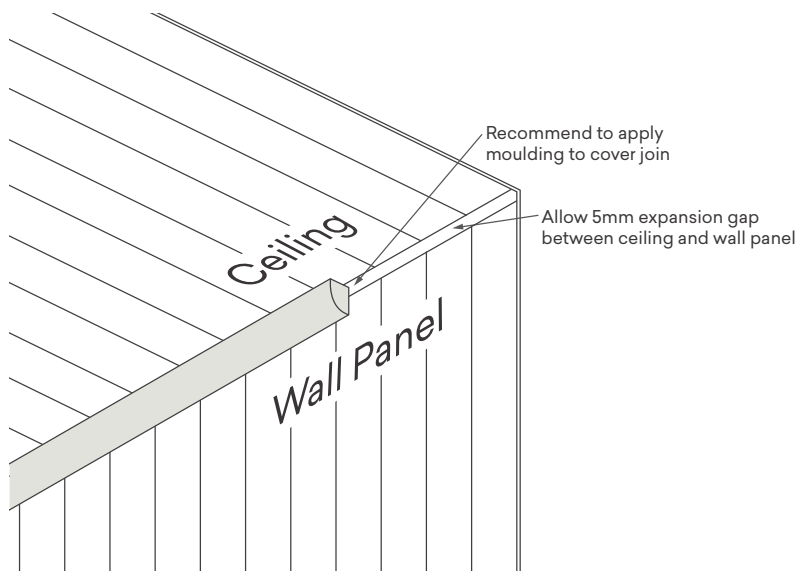

6.9.3 Ceiling finishing

Wall to ceiling option

Various options are available for finishing the junction between the wall and ceiling. These include:

- Timber Cornice/Mould: Utilising timber cornice or moldings to create a decorative transition between the wall and ceiling.
- Plaster Cornice: Installing plaster cornice, which is another popular choice for adding a refined look to the wall-to-ceiling interface.
- Timber Quad/Bead, Quad, Scotia, Ovolo: Opting for timber quad, bead, scotia, or ovolo profiles, which offer different design possibilities for achieving the desired aesthetic.
- Square set junctional shadow line utilising the 5mm expansion gap.
- Please note that these are just suggestions, and there are numerous plasterboard cornices and timber mouldings available through various timber, hardware, and plasterboard suppliers. The displayed images and profiles are not exhaustive; they serve to demonstrate the wide array of possibilities for finishing and detailing Surround by Laminex® panel installations. You have the freedom to explore and select from a diverse range of options to suit your preferences and requirements.

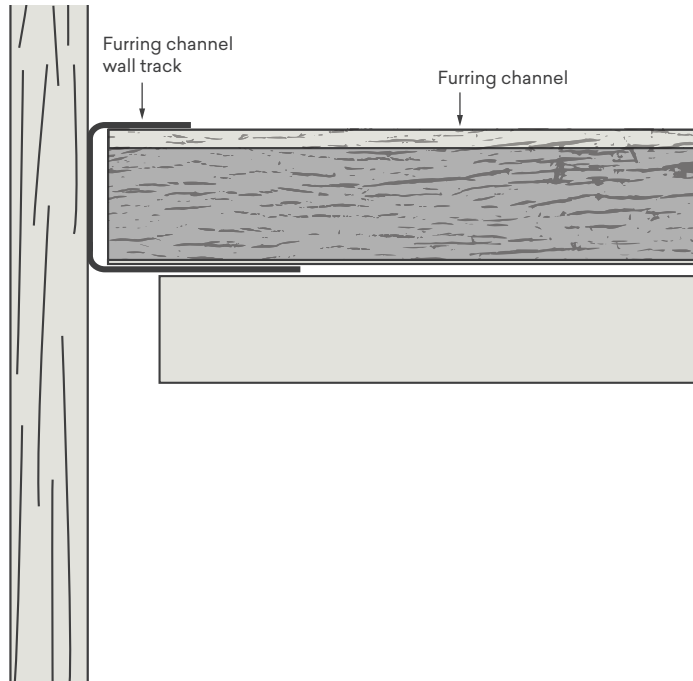

Butt end alternatives

In situations where longer sheets are necessary for ceilings or when the product is used horizontally on walls, it may be required to join sheets end to end. However, Laminex New Zealand® recommends against end-butting the sheets. This is because the building frame may experience movement over time, coupled with environmental changes, which could lead to slight shifts in the panels. Consequently, this movement could cause the joint sealant (gap filler) and paint to crack, resulting in an unsightly and uneven caulked joint.

To avoid these issues, Laminex New Zealand advise exploring alternative ways to detail sheets that need to meet, allowing the profile to continue without joining the sheets directly end to end. By considering other methods of joining, you can achieve a more seamless and aesthetically pleasing result for your Surround by Laminex® panel installation.

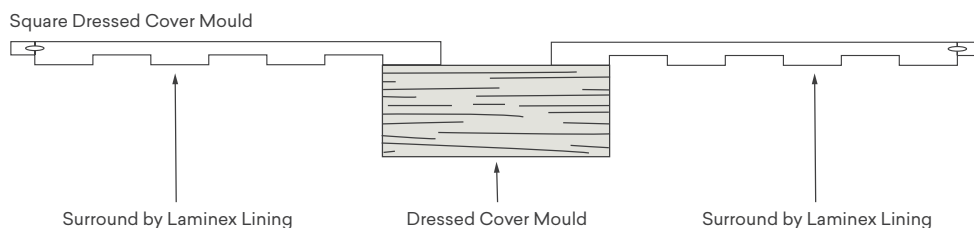

6.10 Use and fixing of dado rails and mouldings

Dado rails or equivalent timber mouldings should be employed as a finishing trim:

1. Along the join between any two different Surround by Laminex panel profiles used together.
2. Where a Surround by Laminex® panel finishes part way up a full height wall.
3. Where the top edge of a Surround by Laminex panel may be viewed from a void or higher position in the property.
4. To delineate between Surround by Laminex panels and a transition to painted or textiled finishes on the same wall.

Various options for finished timber trims, moulding and dado or chair rails are available from various building and timber product suppliers.

6.11 Installation adjacent to fireplaces

Safety: When planning to install Surround by Laminex® wall panels near your fireplace, safety is the most important consideration.

Before installing a fireplace make sure you have checked all safety standards and clearance rules that apply. Regulations for the distance required between a fireplace unit and any combustible material are set out in the manufacturer's technical installation literature and relevant solid fuel, gas, and electric heating appliance installation standards. Please consult with a professional heating appliance specialist on any building code and regulatory requirements.

- Ⓢ Standard Surround by Laminex panels are made from MDF, which is classified as a combustible (Group 3) material. Surround by Laminex must only be installed in locations where a Group 3 (or above) combustible material is permitted adjacent to the heat source.
- Ⓢ Damage caused by installation adjacent to or around a fireplace is not protected under warranty. Smoke, creosote, ash and soot deposits may permanently damage or impact the appearance of the panels and may be difficult to clean.
- Ⓢ Damage to Surround by Laminex panels caused by a poorly maintained fireplace, flue or other fittings and fixtures used in association is not protected under warranty.

The fireplace design, type of fuel it uses and whether it emits heat, smoke, embers or other pollutants to the surfaces and fixtures nearby should all be taken into consideration when planning your project. Please hire a professional tradesperson if you need any assistance when installing your Surround by Laminex panels.

Types of fireplaces

There are many kinds of fireplaces which are defined by the type of fuel and the overall design of the appliance.

Fuels may include: wood burning, gas burning, ethanol burning, pellets, alcoholic gel, liquid fuels, electric, etc.

Design styles may include: open hearth, closed hearth (with doors), freestanding stoves, enclosed zero clearance fireplaces.

There are other bespoke designs or modified versions of traditional fireplaces.

Installation of Surround by Laminex on walls adjacent to a fireplace

Please follow all instructions for Surround by Laminex determined by the type of wall to which the panels will be affixed.

Where a purchased fireplace unit is used, it is very important to follow the manufacturer's instructions that guide what types of materials should be considered for use around the appliance, taking note of instructions for non-flammable and combustible materials.

Surround by Laminex cannot be used in any location or on any surface which are restricted from use of combustible materials.

Some fireplaces (e.g. open hearth – wood burning) are constructed with an open-faced firebox in brick or stone and are part of the architecture of a property where no manufacturer's guidance is provided. Where this is the case, please consult with a licensed industry specialist to ensure construction is in accordance with the New Zealand Standards and New Zealand Building Code.

A guide to names of fireplace elements

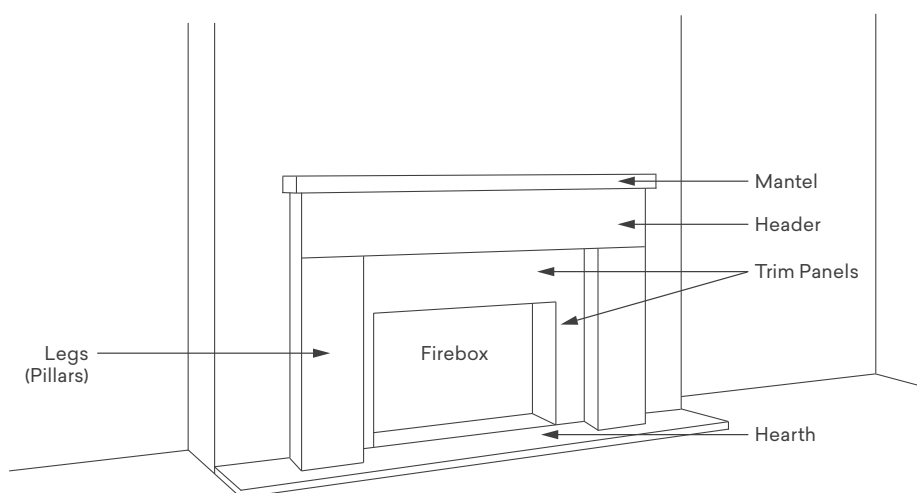

Traditional fireplaces (open or closed)

Surround by Laminex® panels may be used adjacent to the fireplace surround / trim panels, legs, jambs, pillars, or above the mantelpiece where a distance of at least 400mm is maintained between the external edges of the firebox and the closest edge of the panel.

Surround by Laminex panels cannot be used for any of the following elements of a fireplace:

- Inside or around the firebox
- Hearth/plinth
- Legs, jambs, or pillars
- Surround or trim panels
- Header, corbel or mantelpiece

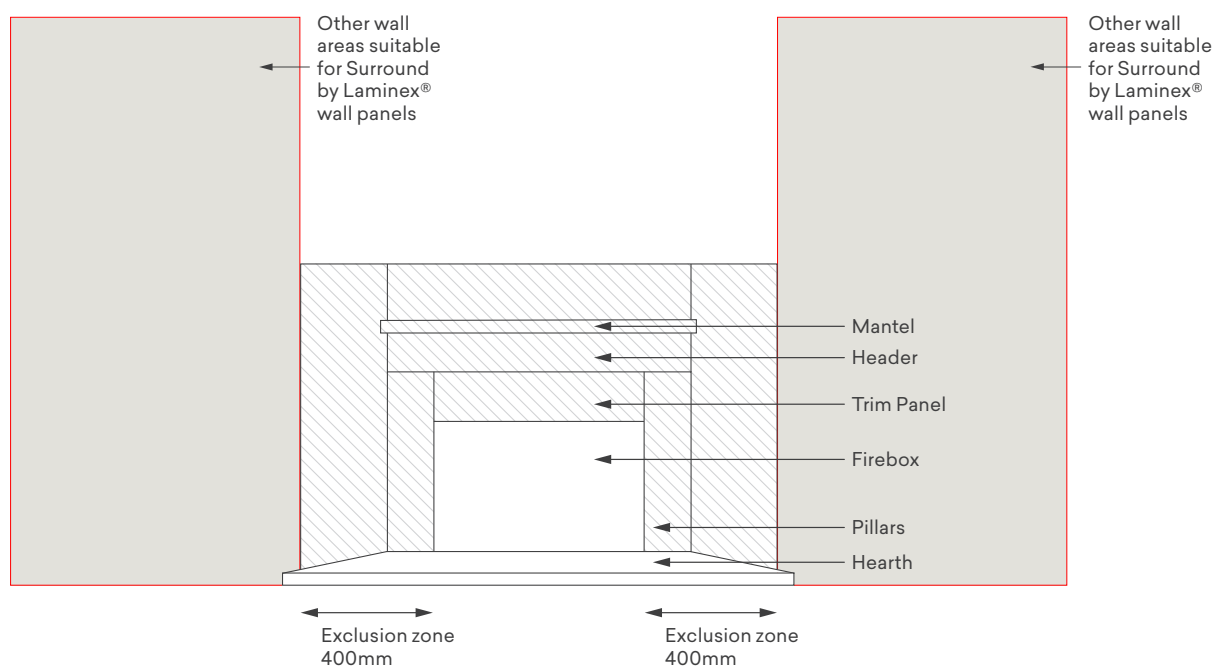

Freestanding fireplaces

Surround by Laminex® panels may be used on walls adjacent to the fireplace or on a wall behind a freestanding wood burner where there is a maintained distance of at least 500mm from the nearest edge of the flue or heat conducting material.

Always observe the heating appliance manufacturers guidelines:

- Distances if greater than 500mm.
- Confirm combustible materials are suitable.

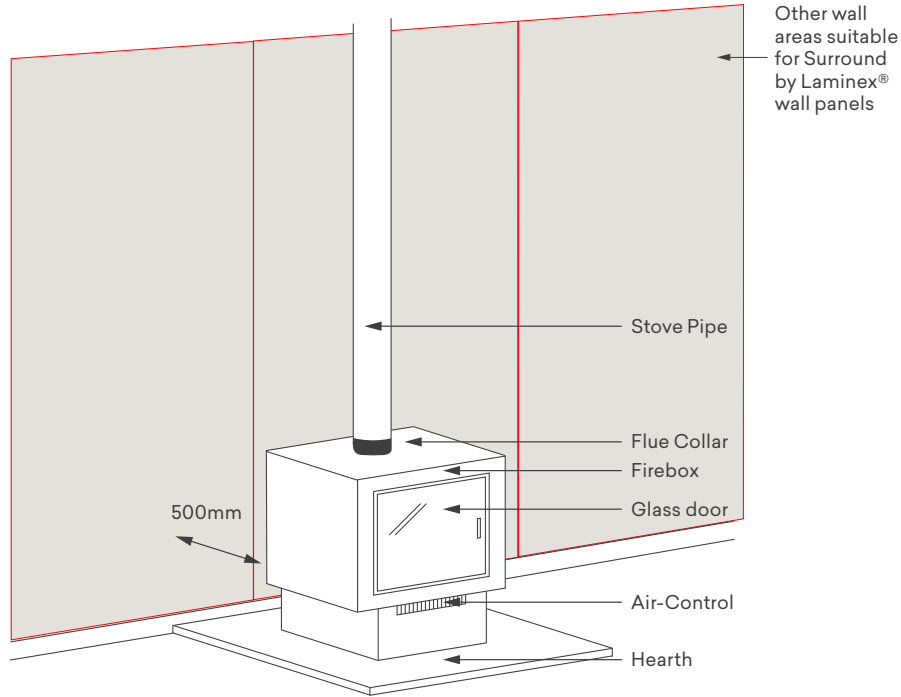

Zero clearance fireplaces

Surround by Laminex panels may be used up to the sealed edge of a zero clearance fully insulated self-contained firebox when installed using the manufacturer's instructions.

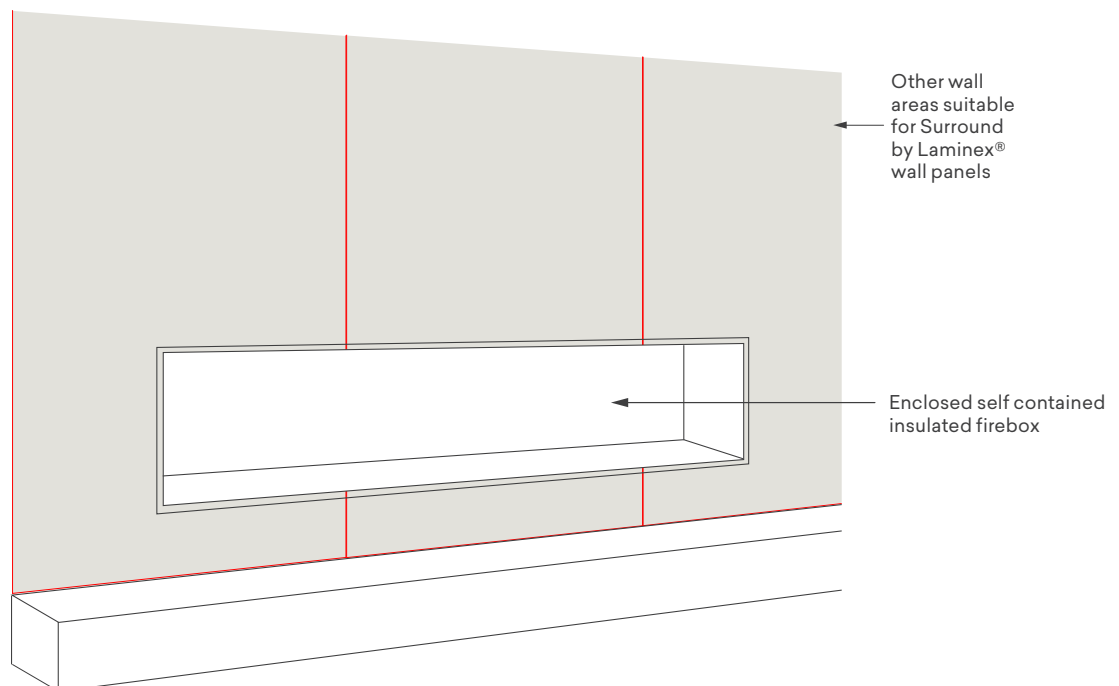

6.12 General power outlets (GPO)

General power outlets can be installed onto either curved or flat profiles as outlined below.

Always use an electrician when working around electrical outlets.

6.12.1 General power outlets (GPO) - for curved profiles

For curved profiles, it is recommended to create a flat area for the GPO to be installed on. This can be achieved by using a router or multi tool.

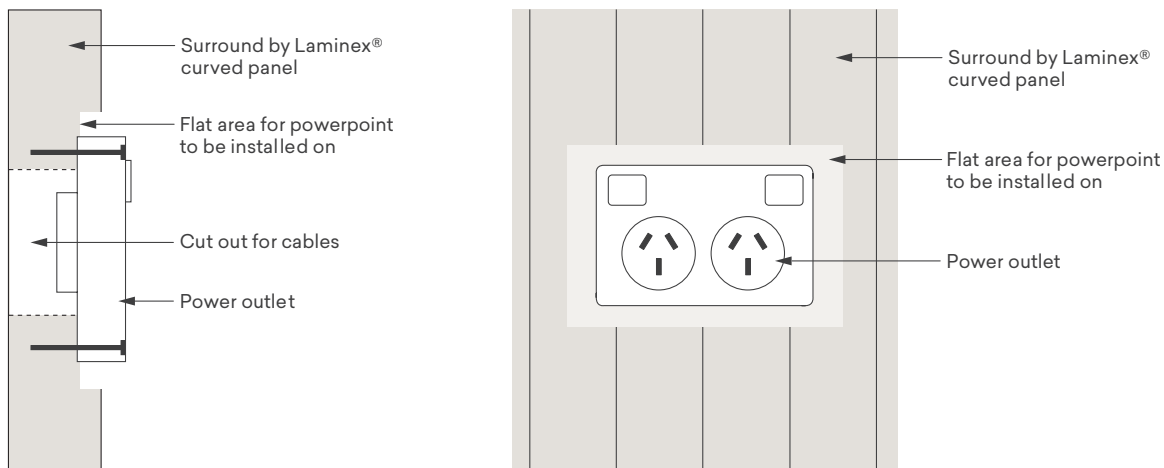

6.12.2 General power outlets (GPO) - for flat profiles

For flat profiles it is recommended to fix the GPO to the front face of the panel.

Once installed it is important to fill in any spaces at the back of the GPO to ensure dust and moisture do not have access to the back of the outlet.

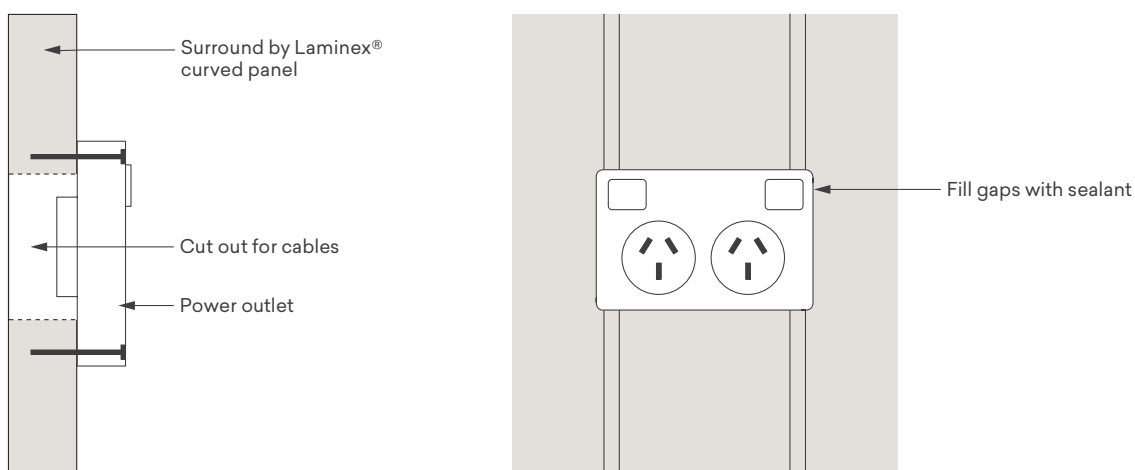

6.13 Skirting boards

You can hide the expansion gap by installing a skirting board on top of the Surround by Laminex® panel. When doing this, it is important to include a spacing block in between the skirting and frame.

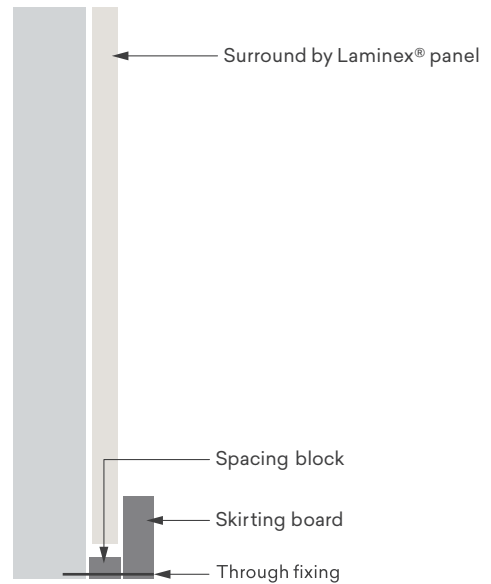

Add a trim to finish the panel installation. This can be achieved by attaching an L angle trim to the rear of the panel. By doing so, it will allow for any expansion that may occur.

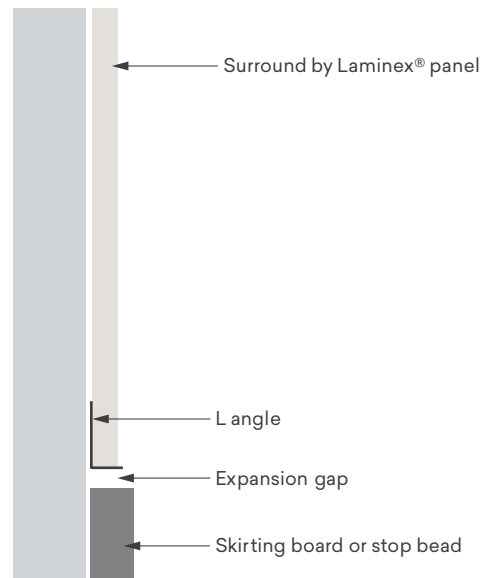

Finish your wall by installing a skirting board to the bottom of the wall, allowing room for an expansion gap. You can then fill the expansion gap with caulking to create a smooth complete look.

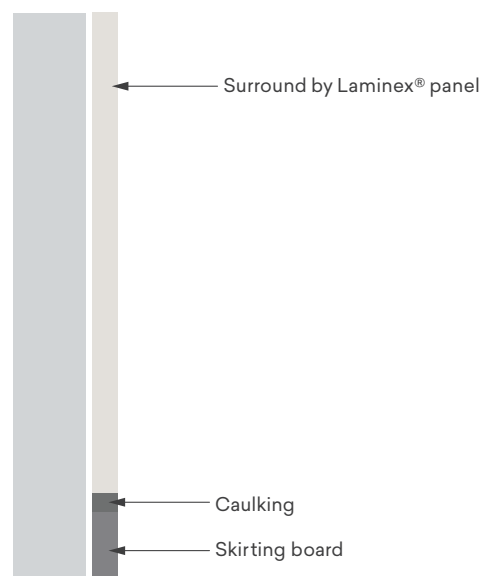

6.14 Curving panels guide

Surround by Laminex® can be curved to create a rounded structure. Before the panel is curved, it must firstly be cut (called kerfing).

Kerfing is a technique used to create flexible or curved shapes in various materials, including wood, plastic, or metal. The process involves making a series of parallel cuts along a specific line or curve in the material.

To begin the kerfing process on a Surround by Laminex panel, you will need a suitable cutting tool, such as a table saw, powered saw, or router, depending on the material you are working with and whether working on site or in a workshop. Selecting a cutting tool appropriate for the material's thickness and fully supporting the material during cutting is critical.

Note:

- Curving should only be undertaken by a person experienced in kerfing and mould making.
- Fire resistant product (E1 MDF FR) cannot be curved.
- Curving required and outcome will vary by profile.
- As every installation is different, the following information is for guidance only. Additional cuts maybe required depending on the panel profile, installation and the outcome desired.
- Before kerfing panels, always trial kerf/cut a small sample of a given profile to ensure you will achieve the curving result you are after - as you may need to adjust the number of cuts and cutting depth.

Panel profile and kerfing guidance

Batten 25



Classic VJ 100

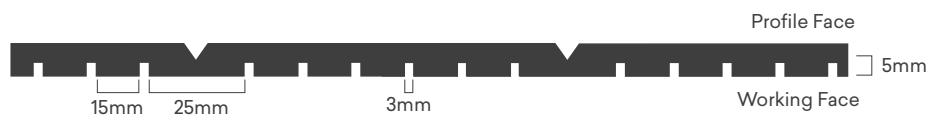

Demi Round 40

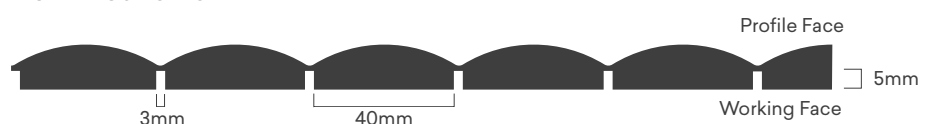

French Stripe 30



Scallop 45



Scallop 135

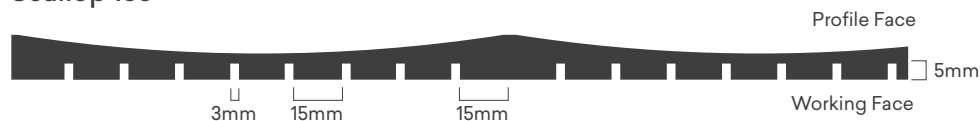

Planning is necessary for positioning the groove at the join. We recommend allowing a 10mm gap between the groove and end of the join.

All measurements are nominal.

6.14.1 Guidance for kerfing

Profile	Minimum Curved radius (mm)	Spacing between the grooves (mm)	Groove depth (mm)	Groove width (mm)
Batten 25	500	Spacing between each point 22mm located at the centre of the batten profile.	5mm depth on the profile area.	3
Classic VJ 100	500	Spacing between each point is 25mm with the VJ profile located at the centre. The spacing between the non-profile area is 15mm.	5mm depth of all grooves.	3
Demi Round 40	600	40mm spacing from every semi-circle profile end.	5mm depth of all grooves.	3
French Stripe 30	500	5mm spacing centre in from each side of the profile.	5mm depth of all grooves.	3
Scallop 45	600	10mm spacing from the semi-circle profile border and 20mm spacing at the curved profile.	6.5mm depth of all grooves.	3
Scallop 135	600	15mm off from the centre of the profile and spacing between each groove is 15mm.	5mm depth of all grooves.	3

The starting point of the first groove should be positioned from the joint and aligned with the spacing guidelines provided in the above table.

All measurements are nominal.

6.14.2 Installation and finishing process – structure

Preparing and designing

- Designing cabinet components for decorative curved panels needs careful planning for the support structure of the kerfed panels.
- Always check the radius of the intended structure is aligned with the selected Surround By Laminex® profile.
- Minimum radius under warranty is 600mm for Demi Round & Scallop profiles.
- Minimum radius under warranty is 500mm for all other Surround by Laminex profiles.
- It is important to choose a suitable profile for the degree of curvature involved in the project.

Designing the supporting structure

This can be approached in one of two ways:

- A mould structure is built to which the Surround by Laminex curved pieces are combined with sheets of 3mm to 6mm raw medium density fibreboard (MDF) or 3mm to 6mm bending plywood.
- A curved substructure to which the Surround by Laminex panels is affixed which forms a permanent section of the integral cabinetry build.
- Before kerfing panels, always trial kerf/cut a small sample of a given profile to ensure you will achieve the curving result you are after - as you may need to adjust the number of cuts and cutting depth.

Using a substructure

If using a curved substructure (full substrate), use 3mm to 6mm bending plywood or 3mm to 6mm raw MDF. Long or short cut needs to be planned as a formwork to fix the kerfed Surround by Laminex® panels to.

An open frame design is subject to more challenges in fixing. If used, a minimum of top and bottom rails in 16mm MDF or PB with central ribs at a spacing of every 250mm. Please note the degree of curvature will determine how many ribs are required.

Refer to the 'Guidance for kerfing' table for the recommended interval and depth of the kerf cuts based on the profile of the panels.

Cutting and bending the panel

Mark the locations for the kerf cuts using a pencil or marking tool. Refer to the 'Guidance for kerfing' table for spacing between the grooves.

Set up your CNC or manual cutting tools to the required settings outlined in the 'Guidance for kerfing' table. A jig can be created for more accurate even spacing. Normal woodworking tooling is required noting that cutting tips need to be 3mm wide.

Adjust the blade height, depths of cuts and positions according to the 'Guidance for kerfing' table. It is important not to exceed the depth of the cut as failure of the sheets may occur. Cut depths exceeding the 'Guidance to kerfing' table can result in visual imperfections on the finished face material.

Ensure even coverage but avoid using excessive glue that might squeeze out when clamped.

Painting and inspection

Preparation for painting – refer to section 7.1 - 'Painting'.

Fixing to the interior structure frames

Ensure that your interior structure frames are constructed and ready for installation.

Have your kerfed Surround by Laminex panels, suitable adhesive clamps, screws, and other necessary tools on hand.

Measure the dimensions of the structure openings where you intend to install the kerfed Surround by Laminex panels.

Transfer these measurements to the kerfed panels, marking the areas where the panels need to be trimmed to fit precisely.

Using a powered saw, trim the kerfed Surround by Laminex panels along the marked lines to match the dimensions of the structure openings. Always make sure that the panels are fully supported while machining and handling.

Sand the cut edges to ensure a smooth flake/chip free surface.

Installing kerfed panels to structures

Fix kerfed Surround by Laminex panels to prepared structures.

Ensure all expansion gaps are maintained (2mm per meter minimum) between panels and fixtures to permit the panels to react in environmental conditions. All expansion gaps must be filled with flexible sealant (25% movement minimum).

All penetrations through the panels must be sealed on all edges.

Wet area sealant must be maintained for all Internal Moisture Areas.

Painting and inspection

Preparation for painting – refer to section 7.1 - 'Painting'.

Manual cutting on site

Mark the locations for the kerf cuts using a pencil or marking tool.
Refer to the 'Guidance for kerfing' table for spacing between the grooves.

Place a straightedge or guide along the marked lines to ensure straight and even cuts.

Carefully make the kerf cuts along the marked lines, using a slow and controlled motion. Keep the panel securely clamped to prevent any movement.

Make sure the panels are always fully supported when cutting and handling.

Measure the dimensions of the wall openings where you intend to install the kerfed Surround by Laminex® panels.

Transfer these measurements to the kerfed panels, marking the areas where the panels need to be trimmed to fit precisely.

Using a powered saw, trim the kerfed Surround by Laminex panels along the marked lines to match the dimensions of the wall openings. Always make sure that the panels are fully supported while machining and handling.

Sand the cut edges to ensure a smooth flake/chip-free finish surface.

Gently bend the panel along the kerf cuts, following the desired radius.

The kerf cuts will allow the panel to flex when the process handling and installation are followed correctly. Preventing breakage requires the panel to be supported at all times during handling.

Always follow the adhesive manufacturer's instructions.

Refer to section 2.1.4 - 'Adhesives' in this manual.

Please ensure careful handling, transport, and fixing of the curved panel due to its increased flexibility within the panel.

6.14.3 Installation and finishing process – walls

Preparing and designing

- Designing cabinet components for decorative curved panels needs careful planning for the support structure of the kerfed panels.
- Always check the radius of the intended structure is aligned with the selected Surround By Laminex® profile.
- Minimum radius under warranty is 600mm for Demi Round & Scallop profiles.
- Minimum radius under warranty is 500mm for all other Surround by Laminex profiles.
- It is important to choose a suitable profile for the degree of curvature involved in the project.

Designing the supporting structure

- A mould structure is built to which the Surround by Laminex® curved pieces is affixed.
- A curved substructure to which the Surround by Laminex panels is affixed which forms a permanent section of the integral wall structure.
- Please note the degree of curvature will determine how many stud fixings are required.
- Refer to the 'Guidance for kerfing' table for the recommended interval and depth of the kerf cuts based on the profile of the panels.

Cutting and bending the panel

Setup the work place to fully support the panels and mark the locations for the kerf cuts using a pencil or marking tool. Refer to the 'Guidance for kerfing' table for spacing between the grooves.

Place a straightedge or guide along the marked lines to ensure straight and even cuts.

Make sure the panels are always fully supported when cutting and handling.

Measure the dimensions of the wall openings where you intend to install the kerfed Surround by Laminex panels.

Transfer these measurements to the kerfed panels, marking the areas where the panels need to be trimmed to fit precisely.

Set up your table saw or manual saw cutting tools to the required settings outlined in the 'Guidance for kerfing' table. A jig can be created for more accurate even spacing. Normal woodworking tooling is required noting that cutting tips need to be 3mm wide.

Using a powered saw, trim the kerfed Surround by Laminex panels along the marked lines to match the dimensions of the wall openings. Always make sure that the panels are fully supported while machining and handling.

Adjust the blade height, depths of cuts and positions according to the 'Guidance for kerfing' table. It is important not to exceed the depth of the cut as failure of the sheets may occur. Cut depths exceeding the 'Guidance for kerfing' table can result in visual imperfections on the finished face material.

Carefully make the kerf cuts along the marked lines, using a slow and controlled motion. Keep the panel securely clamped to prevent any movement.

Ensure even coverage but avoid using excessive glue that might squeeze out when clamped.

Sand the cut edges to ensure a smooth flake/chip-free finish surface.

Gently bend the panel along the kerf cuts, following the desired radius.

It is recommended to follow the adhesive manufacturer's instructions for the amount to be used and ensure even coverage. Refer to section 2.1.4 - 'Adhesives' in this manual.

Painting and inspection

Preparation for painting – refer to section 7.1 - 'Painting'.

Please ensure careful handling, transport, and fixing of the curved panel due to its increased flexibility within the panel.

6.0 Installation

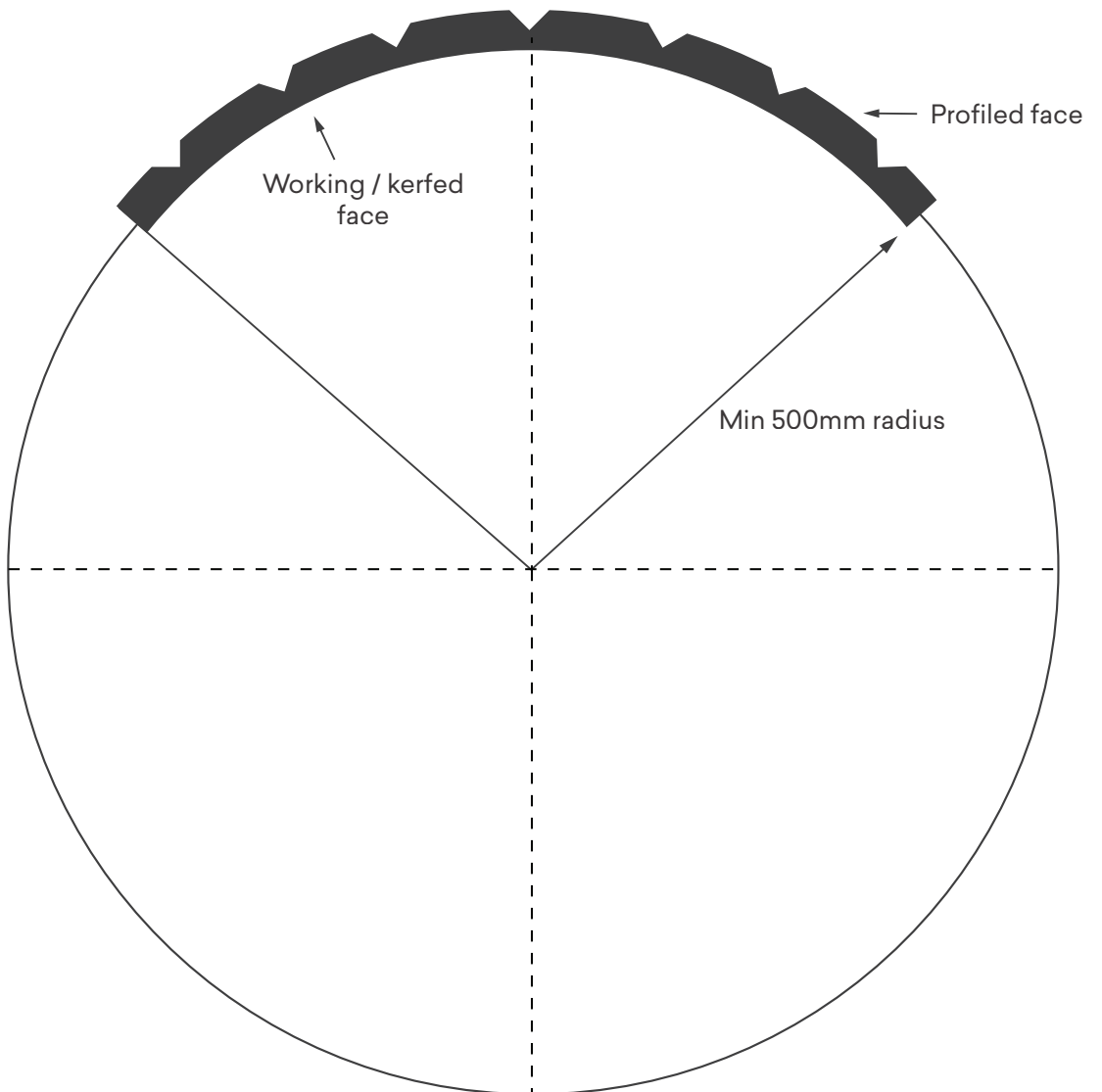
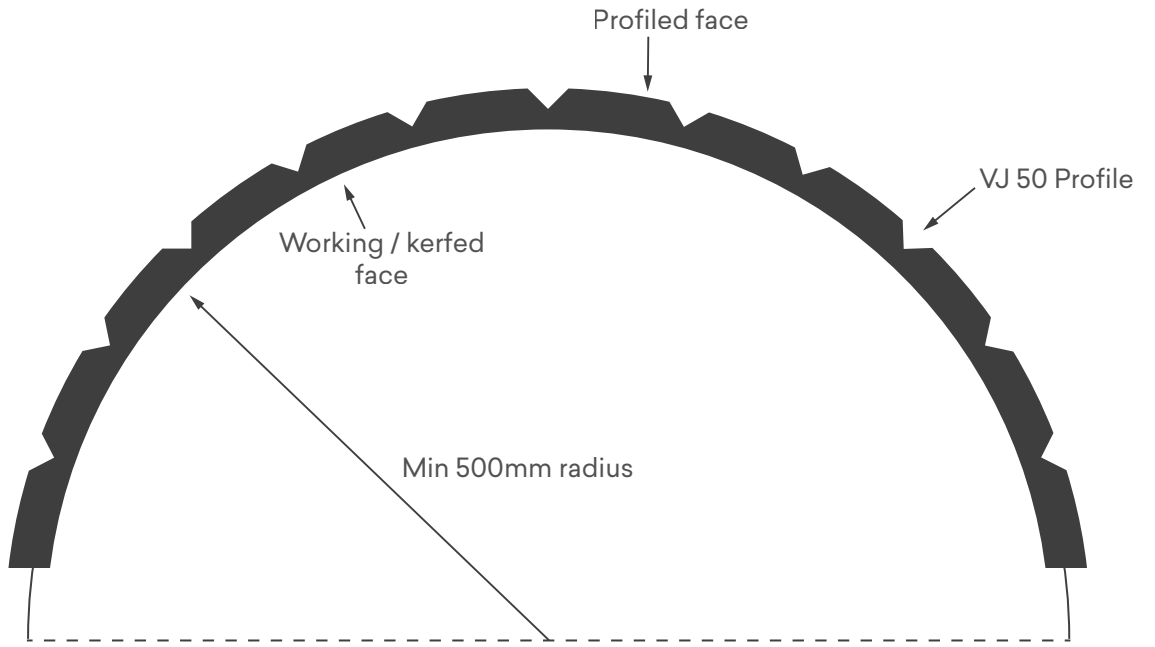

7.1 Painting

Surround by Laminex® is supplied as a pre-primed panel with water-based paint.

Surround by Laminex panels come pre-primed on the decorative face.

Before painting begins, it is important to ensure the surface of the Surround by Laminex panel is properly prepared.

Fill all nail/screw holes and imperfections with a suitable water-based wood filler and allow to dry.

Lightly sand all surfaces to be coated with a fine grit sandpaper or sanding block to obtain a smooth and even finish. Use a sanding sponge or progressively use finer grit sandpaper to achieve a smooth edge free of damage, cracks, dents or notches.

Care must be taken not to abrade the decorative routed areas as this may result in permanent damage of the surface to be painted.

Note: Due to the deep tooling required to produce Scallop 135, extra sanding preparation prior to paint application will be required to achieve a smoother finish of this profile. Machine marks maybe visible in areas with critical light.

Ⓜ Damage to Surround by Laminex panels as a result of surface or panel preparation activities will not be recognised under warranty.

Use a soft brush to remove all sanding/processing dust and contamination before painting commences.

Do not introduce oils, water or solvents in contact with the Surround by Laminex panels during the prepping and painting processes.

Follow all paint manufacturer's directions including checking if the pre-finished base primer is suitable for the intended painted finish.

Ⓜ Claims arising from unsuitable paint types or application, or poor paint appearance or performance, will not be recognised under warranty.

If you are installing Surround by Laminex in a Internal Moisture Area, ensure you follow the additional sealing / priming and painting instructions outlined in section 6.8.

Note: Surround by Laminex as a Fire Resistant (E1 MDF FR) substrate is prohibited for use in Internal Moisture Areas.

Important Information

Note	Details
<p>Ⓜ ONLY use for internal applications.</p>	<p>Claims arising from non-internal applications are not covered under warranty.</p>
<p>Ⓜ ONLY use for wall and ceiling applications.</p>	<p>Claims arising from floor or cabinetry applications are not covered under warranty.</p>
<p>Ⓜ ONLY use for dry area applications.</p>	<p>Claims arising from applications where the product could be contacted by water or liquids, either routinely or by accident, are not covered under warranty.</p>
<p>Ⓜ DO NOT expose to heat or moisture.</p>	<p>Claims arising from frequent or excessive exposure to heat or moisture are not covered under warranty. Claims resulting from failure to adequately seal all exposed faces / edges will not be recognised.</p>
<p>Ⓜ DO NOT butt join panels.</p>	<p>Claims arising from peaking, movement or any failure of sheets in place due to the use of butt joints, are not covered under warranty.</p>
<p>Ⓜ DO NOT expose to prolonged direct or indirect UV light.</p>	<p>Claims arising from prolonged exposure to UV light (natural or artificial sources) resulting in shrinkage, warping are not covered under warranty.</p>
<p>Ⓜ Causes of bowing.</p>	<p>Claims arising from incorrect conditioning, poor storage, exposure to humidity changes, incorrect installation, are not covered under warranty.</p>
<p>Ⓜ ONLY use recommended storage and handling methods.</p>	<p>Claims arising from incorrect fabrication methods are not covered under warranty.</p>
<p>Ⓜ ONLY use recommended fabrication methods.</p>	<p>Claims arising from incorrect fabrication methods are not covered under warranty including minimum radius measurements required when curving.</p>
<p>Ⓜ ONLY use recommended Care and Maintenance methods.</p>	<p>Claims arising from staining or damage attributable to not following Care & Maintenance instructions, are not covered under warranty.</p>
<p>Ⓜ ALWAYS comply with installation methods or expansion gap allowances.</p>	<p>Claims relating to peaking, movement or failure of sheets in place due to insufficient expansion gaps or failure to follow installation requirements, are not covered under warranty.</p>
<p>Ⓜ Bonding directly to plaster, plasterboard, masonry or concrete.</p>	<p>Claims arising from poor bonding or fixing methods, or failure of the substrate to which the panel is fixed resulting in dimensional instability, gaps, bowing, undulations, telegraphing or other failures of the decorative surface or poor bonding, are not covered under warranty.</p>
<p>Ⓜ Always comply with fireplace surround installation guidelines and regulations.</p>	<p>Claims arising from incorrect installation methods, or where appliance manufacturers' distances and building code regulations have not been followed are not covered under the warranty.</p>
<p>Ⓜ DO NOT abrade or damage the routed designs whilst sanding and preparing for painting.</p>	<p>Care must be taken not to abrade the decorative routed areas as this may result in permanent damage of the surface to be painted. Damage to Surround by Laminex® panels from paint preparation or application will not be covered under warranty.</p>
<p>Ⓜ ALWAYS consult painting manufacturers guidelines.</p>	<p>Claims arising from unsuitable paint types or application, or poor paint appearance or performance are not covered under warranty.</p>



Living room feature wall –
Batten 25.

VISIT US

laminex.co.nz

CALL US

0800 303 606

SAMPLES

laminex.co.nz
or 0800 999 939

FOLLOW US

 **@laminexnz**

 **@nzlaminex**

© Copyright 2025, Laminex New Zealand®, SURROUND by Laminex® and Laminex New Zealand® are registered trademarks of Laminex New Zealand® or its related company licensors. SURROUND by Laminex® is marketed and distributed by Laminex New Zealand®, a division of Fletcher Building Products Ltd. 802216001|01.25

SURROUND
by Laminex®

Laminex®
NEW ZEALAND